

CATALOGUE
VOL.5

Taking *Play!*

*To a
new
height*

www.prolandscape.com.my

pro landscape
structure
Malaysia's Premier Play Equipment Manufacturer



ABOUT PRO-LANDSCAPE STRUCTURE

At Pro-Landscape Structure, our playground products are designed and engineered to meet the boundless imagination of children and heighten their enjoyment. With our talented design team, we are able to focus on customized designs and adventurous play activities that meet safety standards. Every year, we strive to push the parameters of innovation, durability, and excitement.

Our equipment are protected with the best warranty, guaranteeing defect-free products, materials, and workmanship under all normal use and service. We insist on the highest standards in customer service. After all, we truly believe that, "children discover the world through play".



OUR QUALITY ASSURANCE



TABLE OF CONTENTS

Si-Camel Play Equipment Series	
Pre-School	07
Basic	14
Intermediate	20
Conceptual Themed Playpark	
Ikan Gapi (<i>Guppy Fish</i>)	43
Butterfly Metamorphosis	44
The Swamp	45
Pondok & Treehouse	46
Soaking Wet	47
Candyland	48
The Giant UFO	49
Si-Camel Play Equipment Series	
Exclusive	50
Challenge	64
Waterplay	80
Independent Items	88
Pro-Builder Outdoor Fitness Series	
Outdoor Gym	98
Parcourse	100
Pro-Park Park Furniture Range	
Benches and Bins	102
Pro-Safe Safety Flooring	
EPDM & Rubber Tiles	103

WHAT'S **NEW** IN CATALOG VOLUME 5?

Flipping through this catalog, if you are a regular, you'll notice that we're coming in with a new approach this time. Pick your product according to the play values you want to include in your play environment. Each is represented with an icon placed beneath the product specification.

There're new colour schemes to mix and match according to your preferences. We won't judge.

And what good is a new catalog without new products in it? Check out our CHALLENGE and WATERPLAY series. We put our blood and tears into it so you can have your laughs and giggles.

DESIGN PHILOSOPHY

It is the guideline that we use to plot our design map and the direction we should cast our effort at, while not limiting creativity in producing products that are both functional and visually charming.

To churn out the perfect outcome, we first ask ourselves these fundamental WHAT questions:

REQUIREMENT The specifications and experience laid out by our clients for us to go by in producing the design

AGE GROUP The intended user of the playground products

LOCATION The physical area where the playground is to be situated, also taking into account the environmental elements and how these will affect the products

SAFETY ZONE Design must accomodate safety margin between products and obstacles

The experience and developmental elements that will be integrated as the functions of the play equipment

PLAY VALUE



Sliding



Climbing



Balancing



Rocking



Spinning



Water



Swing



Imagination



Socializing



Auditory

DESIGN PROCESS

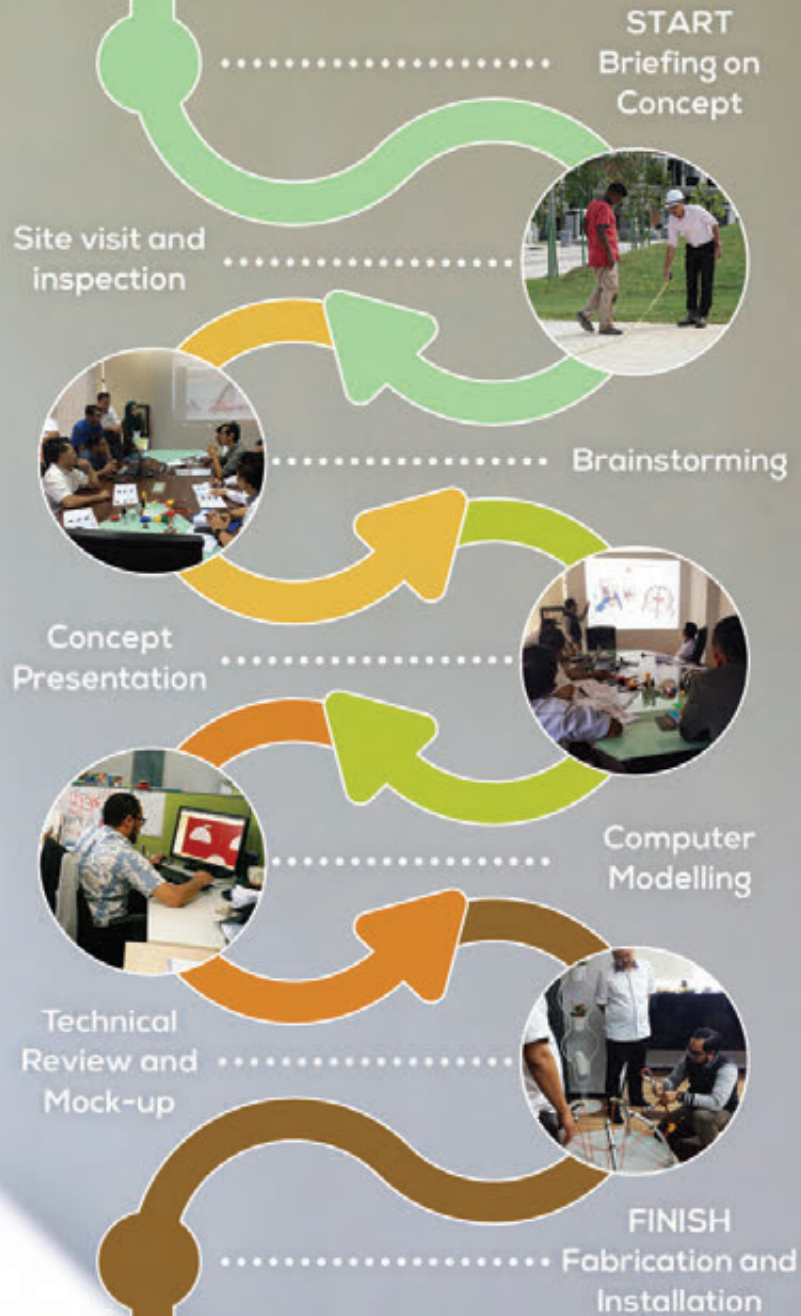

Meeting the requirements of a Quality Management System (QMS) is a big differentiator between reliability and uncertainty. From *Design, Manufacturing, to Installation*, we are committed to total quality management: customer focus, continuous improvement process approach, and strong management commitment backing up the initiatives. This will necessarily trickle down to the final products that you, as a customer, expect to receive.

Today's big word is SAFETY. Adhering to world standard in playground safety is hard work, but absolutely necessary. We have our own Certified Playground Safety Inspectors to keep things in check. Because some risks are just not worth it.

ISO 9001 : 2015 CERTIFIED COMPANY



Copyright © 2018 Pro-Landscape Structure Sdn Bhd (291270-U)

All rights reserved. No part of this catalog may be reproduced, distributed, or transmitted in any form or by any means, without prior written permission by Pro-Landscape Structure Sdn Bhd, addressed below :

No. 53854, Jalan BRP 8/2, Taman Industri Bukit Rahman Putra, 47000 Sungai Buloh, Selangor, Malaysia.
email : info@prolandscape.com.my

Disclaimer

ALL PRODUCTS, PRODUCT SPECIFICATIONS AND DATA ARE SUBJECT TO CHANGE WITHOUT NOTICE TO IMPROVE RELIABILITY, FUNCTION OR DESIGN OR OTHERWISE.

Pro-Landscape Structure Sdn Bhd, the Company, disclaims any and all liability for any error, inaccuracy or incompleteness contained in this catalog relating to any product. Statements regarding the suitability of products for certain types of applications are based on the Company's knowledge of typical requirements that are often placed on our products in generic applications. Parameters provided in datasheets and / or specifications including colour options may vary in different applications and subject to current availability.

PRE-SCHOOL SERIES

Integrated Playset

Sicomel
children play equipment system

Children 2 - 5 years old are just starting to discover their basic external biological functions like movements, balance, grabbing and clutching, and also sight and depth perceptions. At the same time, the boundary line between challenge and out right danger is at its finest. Understanding these, we concocted a perfect recipe of play equipment in our PRESCHOOL SERIES.



SCB16151-065A

Specifications

Length : 4.8m
Width : 3.6m
Height : 2.5m

Colour scheme

Components List

- Mini Astro slide
- Cloud stepper
- Counter panel
- Window panel
- Power panel
- Steering panel
- Butterfly face panel
- Gear panel
- Garden panel
- Bubble panel
- Alphabet panel
- Square deck
- Step deck
- Rung ladder
- Welcome arch deco
- Posts W/ caps



Ages:
2 - 5
years

10 - 12
Children

ASTM
Compliance

Top View - Safe Use Zone

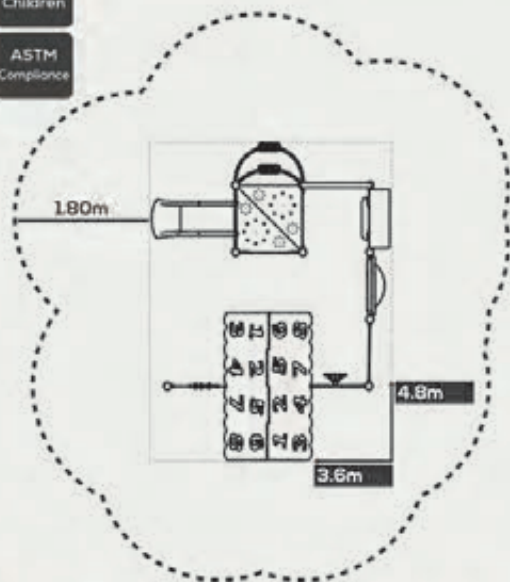

Perspective View



SHIP & JUNGLE

Specifications

Length : 3.8m
Width : 4.1m
Height : 2.6m

Colour scheme

Components List

- Astro slide
- HDPE square platform
- HDPE rectangular platform
- HDPE ship panel
- Rock climber
- HDPE jungle panel
- Spiral climber
- Entrance ladder
- Kiddy structure



Ages:
2 - 5
years

5 - 10
Children

ASTM
Compliance

Top View - Safe Use Zone

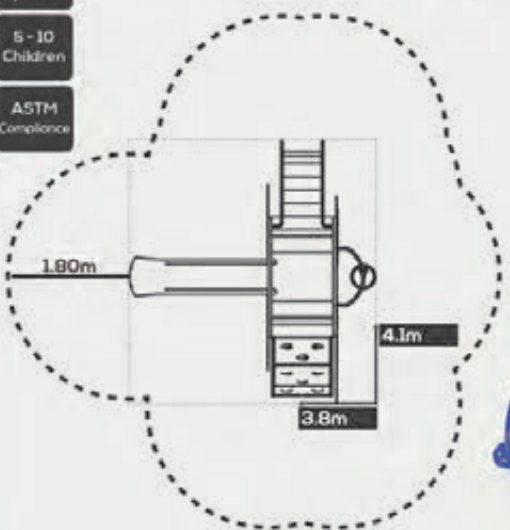

Perspective View

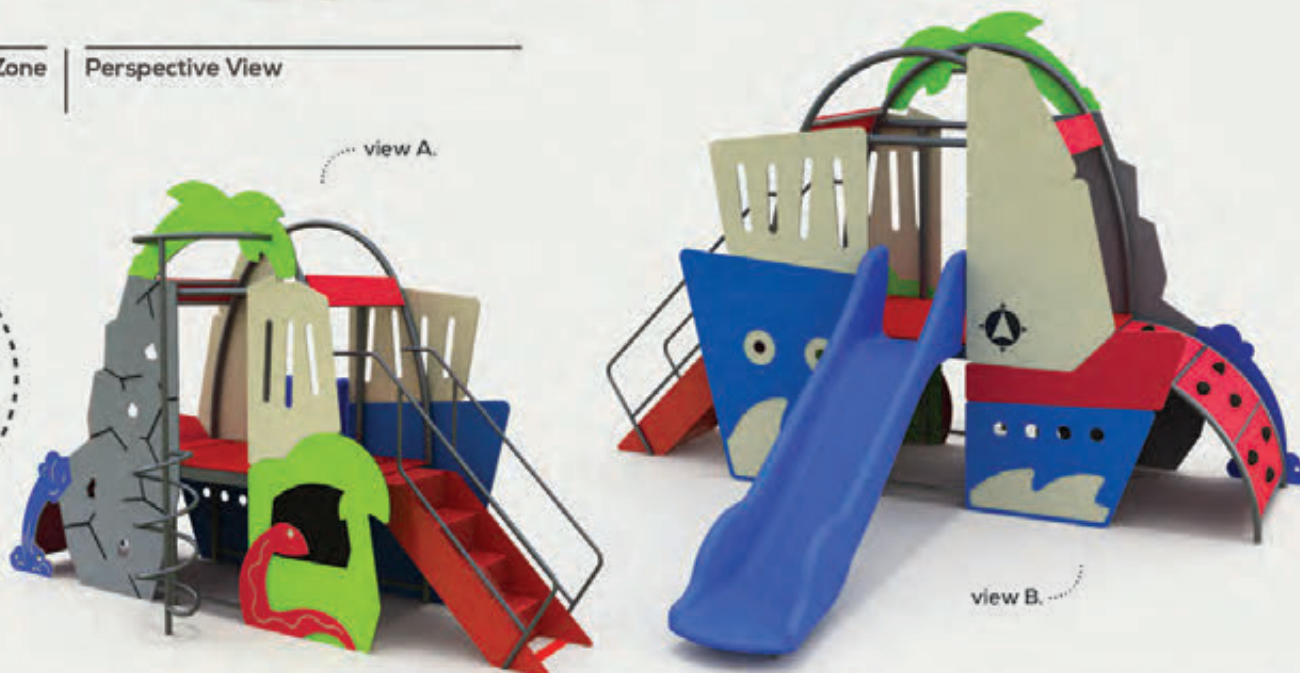



Perspective View



Top View - Safe Use Zone

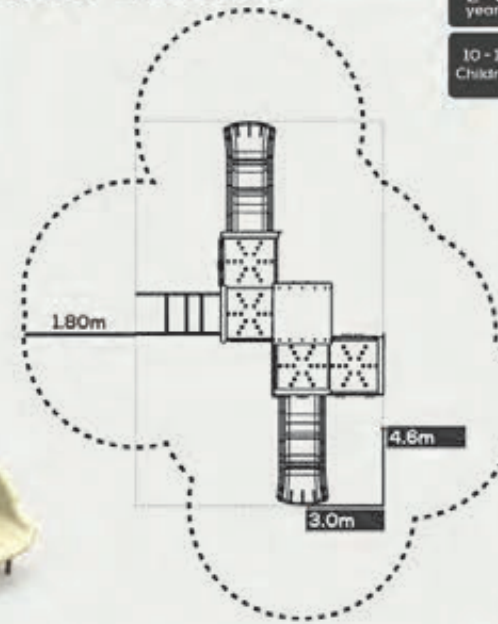

Ages:
2 - 5
years

10 - 15
Children

PLAYGARDEN

Specifications

Length : 4.6m
Width : 3.0m
Height : 2.5m

Colour scheme

Components List

- Mini Astro slide
- Sheep face panel
- Peeping fish panel
- Ladder
- Play window panel
- Cloud deco
- Arch post
- Safety panel
- Flower climber panel
- Roof
- Flower deco
- Race car panel
- Tree climber panel
- Square deck



Perspective View



Top View - Safe Use Zone

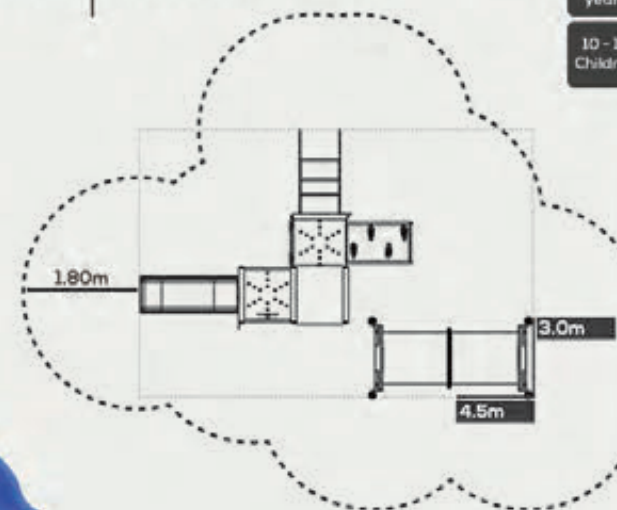

Ages:
2 - 5
years

10 - 15
Children

PLAYGARDEN 2

Specifications

Length : 4.5m
Width : 3.0m
Height : 2.5m

Colour scheme

Components List

- Mini Astro slide
- Sheep face panel
- Peeping fish panel
- Ladder
- Play window panel
- Cloud deco
- Arch post
- Safety panel
- Flower climber panel
- Roof
- Flower deco
- Race car panel
- Tree climber panel
- Square deck
- Lanted rock climber



SCB17081-179A

Specifications



Length : 3.9m
Width : 3.2m
Height : 3.1m

Colour scheme ● ● ●

Components List

- Square deck
- Triangle deck
- Zest roof
- Panel window
- Roof deco
- Rung
- Talking tube
- Castle panel w/ steering
- Mini Astra slide
- XOX panel
- Handhold
- Kick plate
- Posts w/ cap



Ages:
2 - 5
years

10 - 15
Children

ASTM
Compliance

Top View - Safe Use Zone

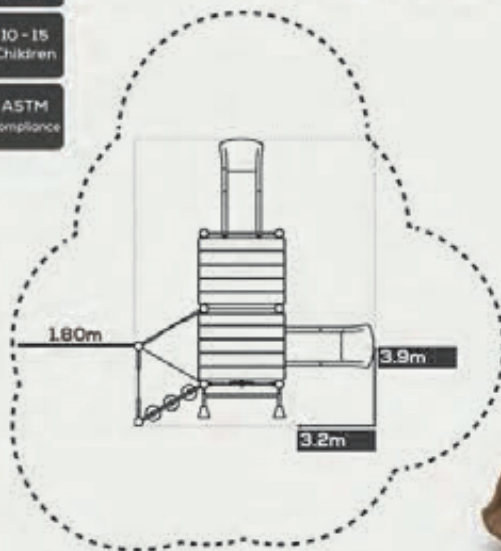

Perspective View



WORKSHOP

Specifications



Length : 2.8m
Width : 2.1m
Height : 2.3m

Colour scheme ● ● ●

Components List

- Workshop 1
- Workshop 2
- Workshop 3
- Posts w/ cap
- Shapes edu panel
- Racing car panel
- Wavy flag



Ages:
2 - 5
years

5 - 10
Children

ASTM
Compliance

Top View - Safe Use Zone

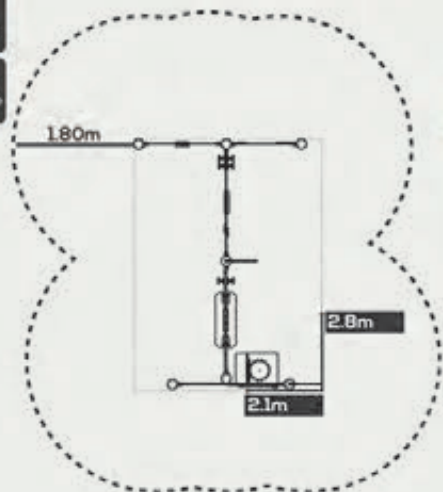

Perspective View

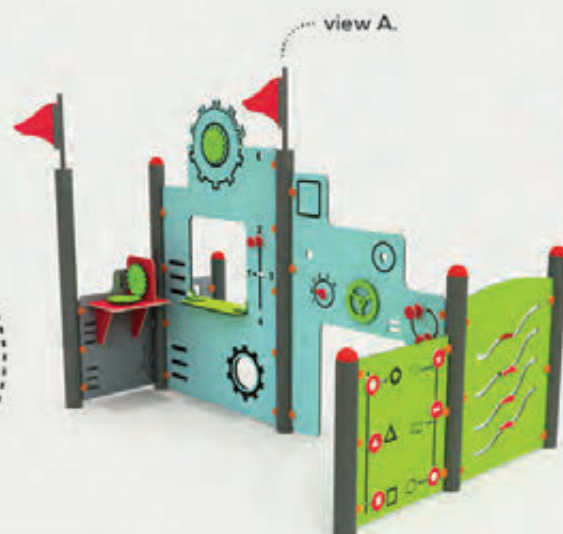



Our signature Anaconda slides are made with double-layered rotomoulded polyethylene plastics that are durable while having sophisticated look to it. But the ace up the sleeve is the unique modular sections that can be partnered up to make a long straight slide or a curved and windy one. When the time comes for maintenance, replace only the defected section, not the whole slide. Not that that's coming too soon though.

Location : Hulu Selangor, Malaysia

CANDY PLAY HOUSE

Specifications



Length : 5.4m
Width : 4.7m
Height : 3.0m

Colour scheme

Components List

- Square deck
- Candy front door
- Candy window panel
- XOX panel
- Awning deco
- Big Conik roof
- Candy roof
- Candy stripe painted posts
- Slotted butterfly panel
- Cherry deco
- Bench
- Candy maze panel
- Elevated crawlway
- Zoom tunnel slide
- Clock panel
- Chime panel
- Bunny panel
- Kickplate

Ages:
2 - 5
years

10 - 15
Children

ASTM
Compliance

Top View - Safe Use Zone

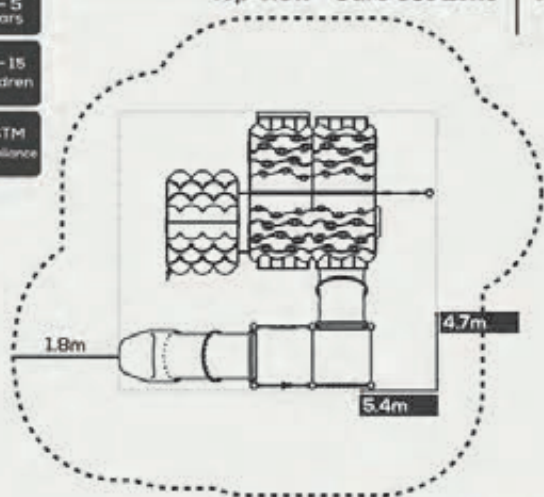

Perspective View



view B.



view A.





Perspective View

Top View - Safe Use Zone

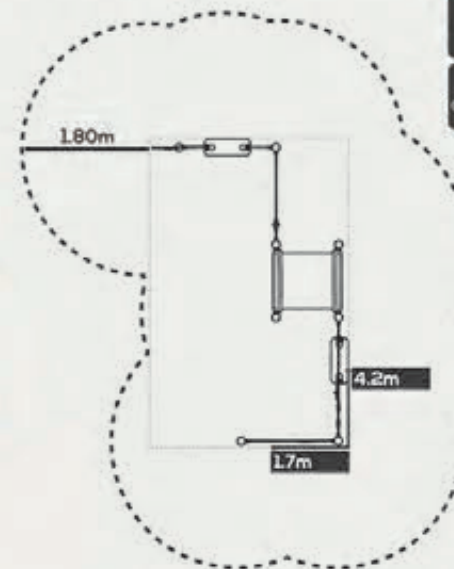

Ages:
2 - 5
years

5 - 10
Children

ASTM
Compliance

PLAY TUNNEL

Specifications

Length : 4.2m
Width : 1.7m
Height : 1.8m

Colour scheme ● ● ● ●

Components List

The flower
Flower entrance
Mini flower
Bushes movable deco
Mini movable panel
Single crawway
Posts



Perspective View

Top View - Safe Use Zone

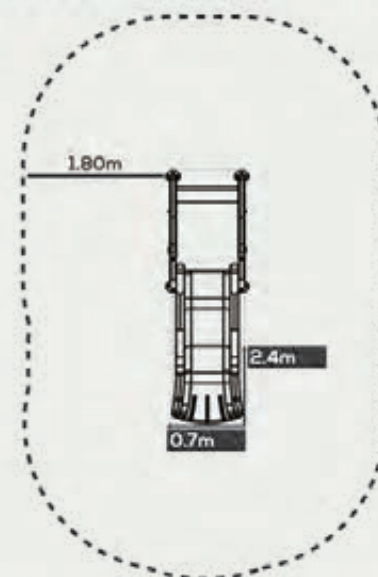

Ages:
2 - 5
years

2 - 3
Children

ASTM
Compliance

AR INDE SLIDE

Specifications

Length : 2.4m
Width : 0.7m
Height : 1.7m

Colour scheme ● ●

Components List

AR A-frame (small)
AR B-frame (small)
AR HDPE deck (small)
AR rod ladder
Screw caps
Mini Astra slide
N footback



BASIC SERIES play equipment use the most common components from our parts bin. Our designers creatively screw the parts together in various configurations to produce diverse models of fast and cost effective integrated sets for children from 2 - 12 years old.

Sicomel
children play equipment system

BASIC SERIES

Integrated Playset

STRAWBERRY
PARK





view A.

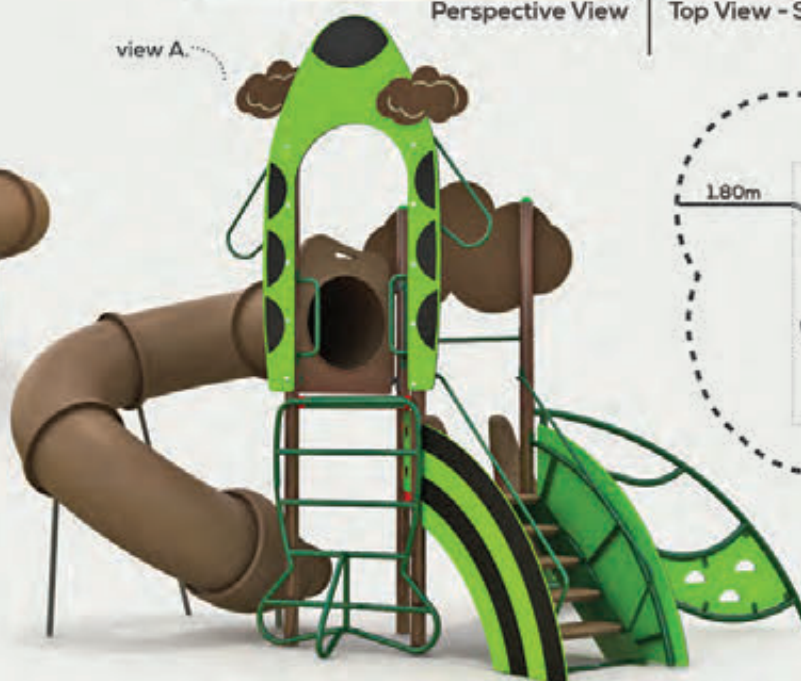

Perspective View

Top View - Safe Use Zone

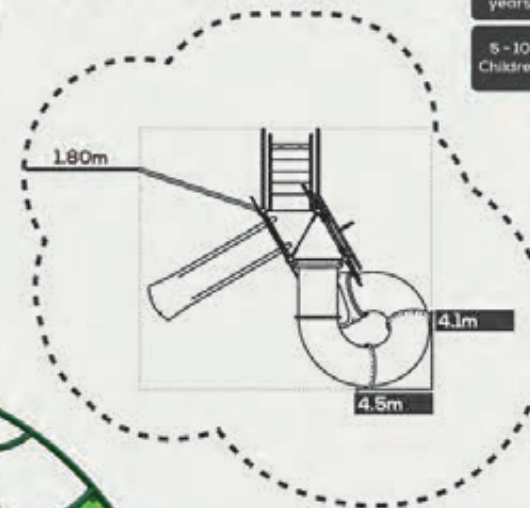

Ages:
5 - 12
years

5 - 10
Children

SCB18042-015A

Specifications

Length : 4.5m
Width : 4.1m
Height : 3.8m

Colour scheme ● ● ● ●

Components List

- Triangle deck
- Spiral tunnel slide
- Astra slide
- Decorative arch climber
- Entrance ladder
- Rainbow deco
- Big cloud deco
- Aeroplane climber
- Panel climber
- Aeroplane HOPE



view B.



Perspective View

Top View - Safe Use Zone

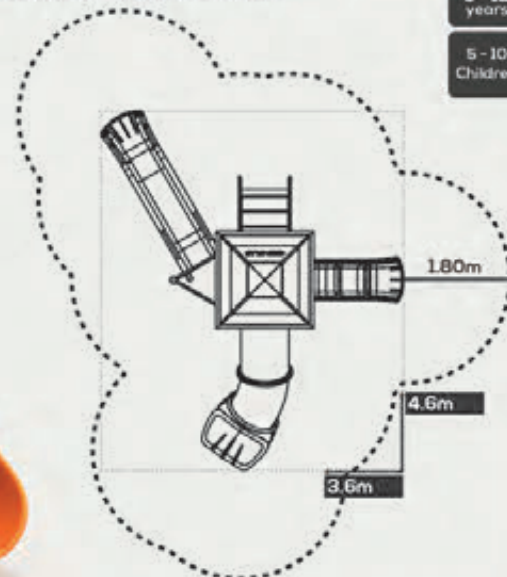

Ages:
5 - 12
years

5 - 10
Children

SCA16052-252A

Specifications

Length : 4.6m
Width : 3.6m
Height : 3.3m

Colour scheme ● ● ● ●

Components List

- Banana tunnel slide
- Slide panel
- Astra slide
- Entrance ladder
- Genius roof
- Mini Astra slide
- Square deck
- Triangle deck
- Kickplate
- Posts w/ cap



SCB16092-243A

Ages:
5 - 12
years

Top View - Safe Use Zone

Perspective View

Specifications



Length : 6.3m
Width : 5.2m
Height : 3.3m

Colour scheme ● ● ● ●

Components List

- Square deck
- Triangle deck
- Entrance ladder
- Mini Astro slide
- Astro slide
- Spiral tunnel slide
- Tree climber
- Zoom tunnel slide
- Rock climber
- XOX panel
- Butterfly movable panel
- Kickplate w/ rung
- Posts w/ cap
- genius roof
- Handhold

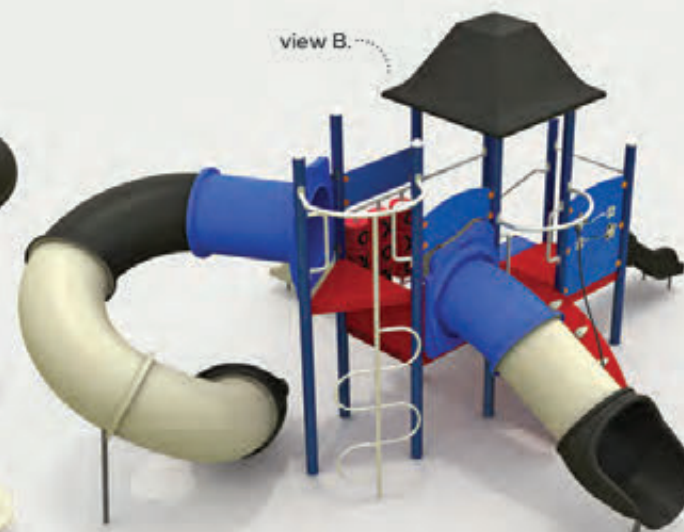
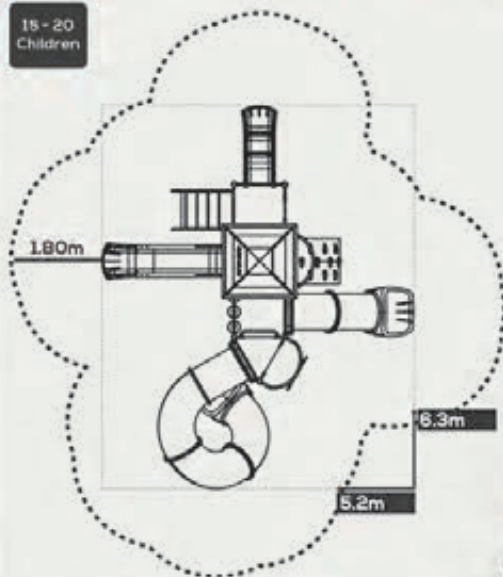

SCB17072-043A2

Ages:
5 - 12
years

Top View - Safe Use Zone

Perspective View

Specifications



Length : 4.7m
Width : 3.4m
Height : 3.9m

Colour scheme ● ● ● ●

Components List

- Square deck
- Clover climber
- Astro slide
- Wobble climber
- Counter panel
- Telescope HDPE panel
- Posts w/ cap
- Flat roof
- Handhold
- Rung
- Climber panel
- Wood panel w/ movable worm
- Garden panel

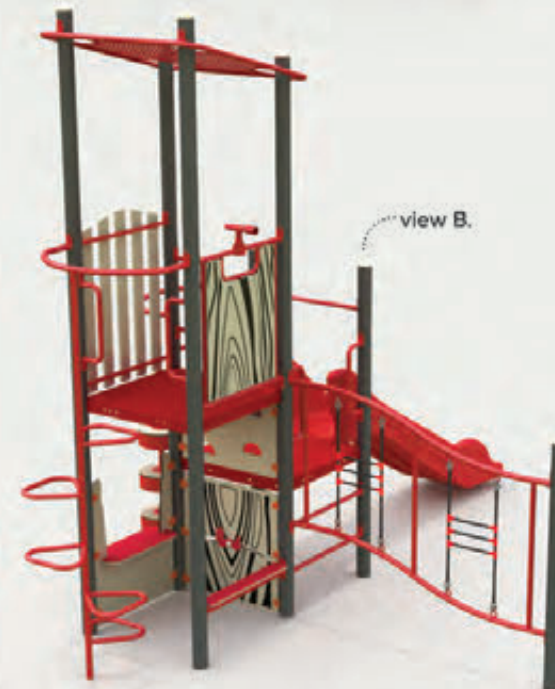
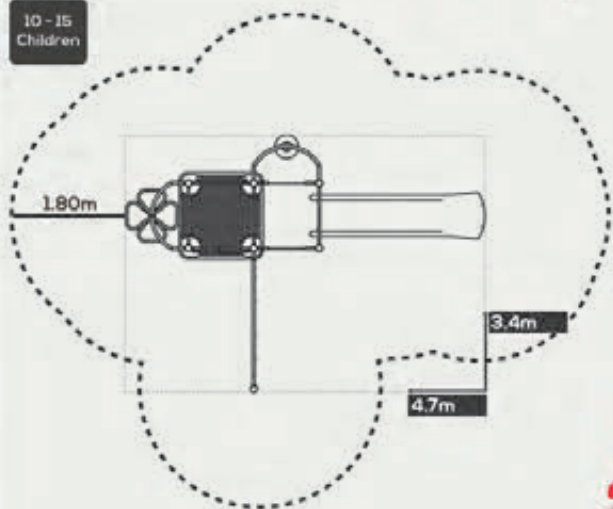



view A.



view B.

Perspective View

Top View - Safe Use Zone

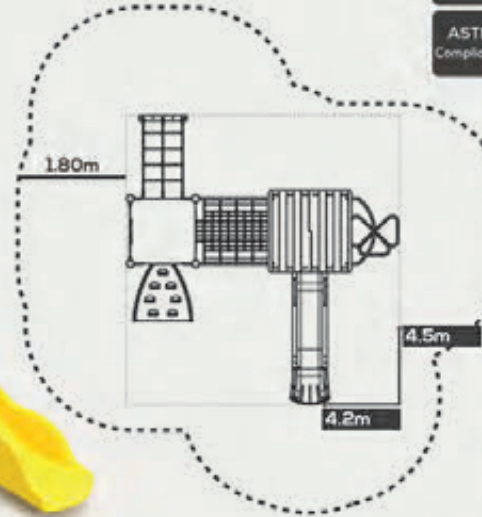

Ages:
5 - 12
years

10 - 15
Children

ASTM
Compliance

SCB17081-211

Specifications

Length : 4.5m
Width : 4.2m
Height : 3.8m

Colour scheme ● ● ● ●

Components List

- Square deck
- Suspended net bridge
- Slatted net climber
- Hole climber
- Astro slide
- Clover climber
- Lion face panel
- Slotted deer panel
- Atop roof
- Posts w/ cap
- Handhold



view A.



view B.

Perspective View

Top View - Safe Use Zone

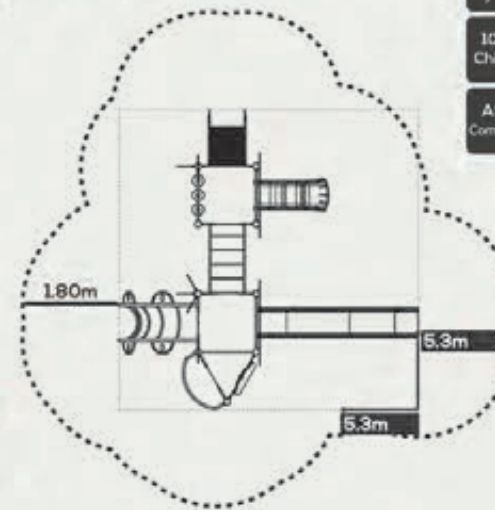

Ages:
2 - 12
years

10 - 15
Children

ASTM
Compliance

SCC18091-195

Specifications

Length : 5.3m
Width : 5.3m
Height : 4.3m

Colour scheme ● ● ● ● ● ●

Components List

- Square deck
- Clover climber
- Astro slide
- Wobble climber
- Counter panel
- Telescope HDPE panel
- Posts w/ cap
- Flat roof
- Handhold
- Rung
- Climber panel
- Wood panel w/ movable worm
- Garden panel



SCA17072-150A

Specifications



Length : 5.2m
Width : 3.7m
Height : 3.5m

Colour scheme ● ● ●

Components List

- Square deck
- Mini Astra deck
- Triangle deck
- Tree climber
- Genius roof
- Astra slide
- Entrance ladder
- Rock climber
- XOX panel
- Safety pane
- Flower deco
- Posts w/ cap



Ages:
5 - 12
years

10 - 15
Children

Top View - Safe Use Zone

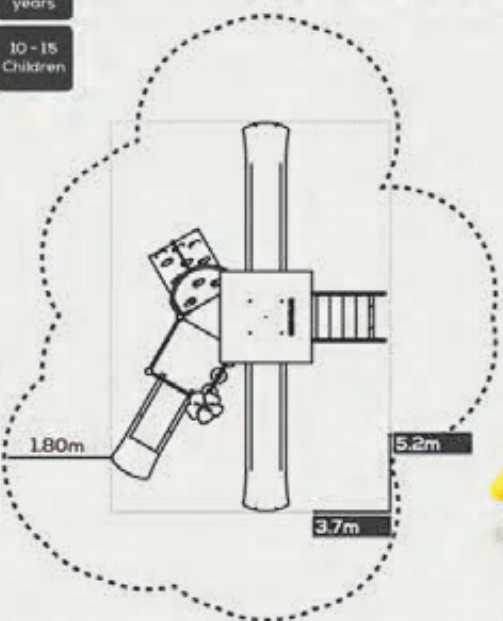

Perspective View



SCB16082-046A

Specifications



Length : 4.9m
Width : 2.7m
Height : 3.3m

Colour scheme ● ● ● ●

Components List

- Square deck
- Step deck
- Mini Astra slide
- Entrance ladder
- XOX panel
- Straight crawl tube
- Steering panel
- Rock climber
- Genius roof
- Leaf deco
- Posts w/ cap



Ages:
5 - 12
years

10 - 15
Children

Top View - Safe Use Zone

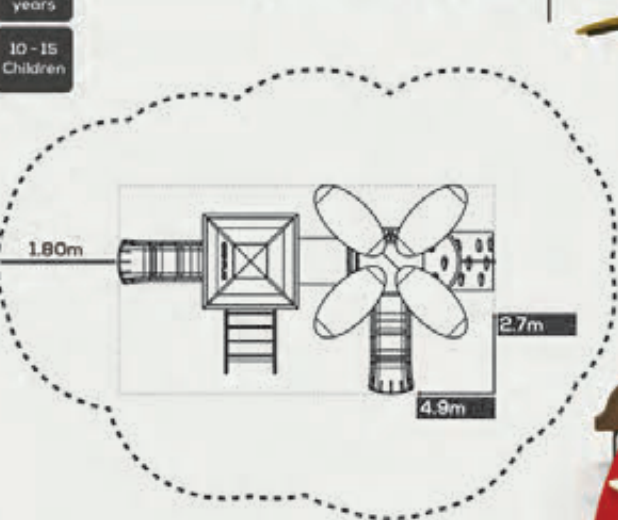

Perspective View





Perspective View



Top View - Safe Use Zone

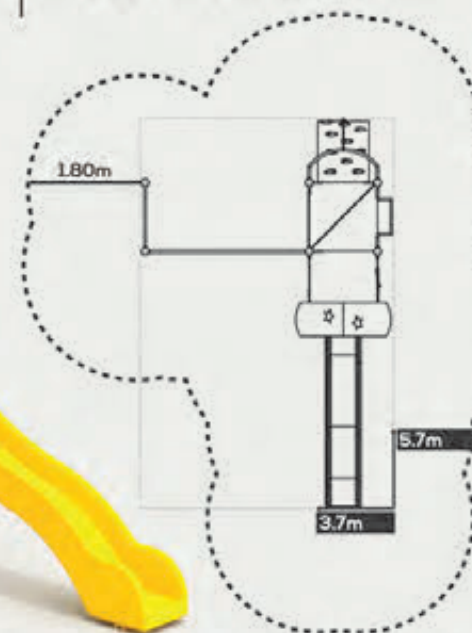

Ages:
5 - 12
years

8 - 12
Children

ASTM
Compliance

SCB17081-096

Specifications

Length : 5.7m
Width : 3.7m
Height : 3.7m

Colour scheme ●●●●

Components List

- Square deck
- Step deck
- Wave slide
- Posts w/ cap
- Mini roof
- Net cross
- Entrance panel
- Window flower panel
- Steering panel w/ movable discs
- Rung
- Kickplate
- Vertical ladder
- Rock climber
- Handhold



Perspective View



Top View - Safe Use Zone

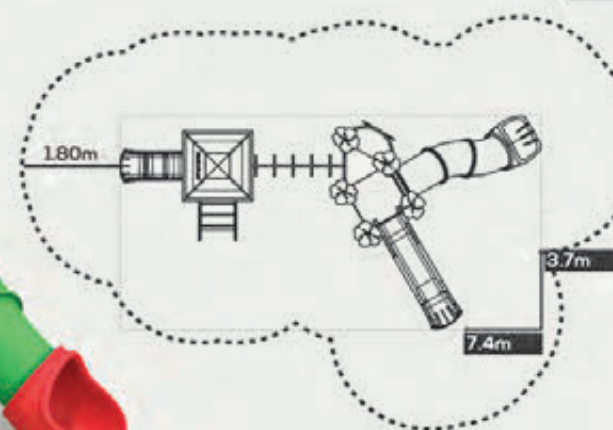

Ages:
5 - 12
years

10 - 15
Children

SCB17092-037A2

Specifications

Length : 7.4m
Width : 3.7m
Height : 3.4m

Colour scheme ●●●

Components List

- Square deck
- Triangle deck
- S-tunnel slide
- Posts w/ cap
- XOX panel
- Genius roof
- Flower deco
- Astro slide
- Mini Astro slide
- Tree panel
- Horizontal loop ladder
- Tree climber
- Entrance ladder
- Rung
- Handhold
- Kickplate



JOOM! @ Anjing

Here are some thing a little bit up in size but won't break your bank. The play equipment from our INTERMEDIATE SERIES are the most popular and sensible choice. You'll be proud to have more equipment, greater play values, and also new colour schemes like all other series.

INTERMEDIATE SERIES Integrated Playset





Perspective View

Top View - Safe Use Zone

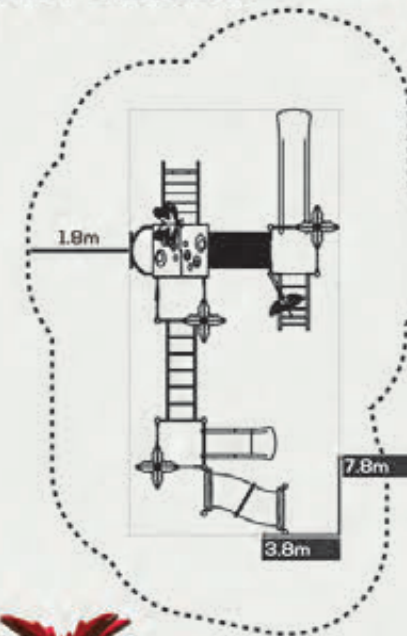

Ages:
5 - 12
years

28 - 30
Children

SCB17172-038BA

Specifications



Length : 7.8m
Width : 3.8m
Height : 3.8m

Colour scheme ● ● ●

Components List

- Square deck
- Astro slide
- Mini Astro slide
- Mini Dome bridge
- Entrance ladder
- Panel climber
- Arch climber
- Tree climber
- Handhold
- Kickplate
- Rung
- Monkey bar
- Ecosystem panel
- Flower face panel
- Slotted butterfly panel
- Canik roof w/ butterfly deco
- S-tube crawlway
- Hummingbird deco
- Palm leaves deco
- Posts w/ cap



SCC16132-037A

Specifications



Length : 7.2m
Width : 2.7m
Height : 2.3m

Colour scheme ●●●

Components List

- Square deck
- Triangle deck
- Banana tunnel slide
- XOX panel
- Handhold
- Entrance ladder
- Elevated tunnel crawlway
- Steering panel
- Rung
- Mini Astra slide
- Horizontal loop ladder
- The little shark panel
- Wobble stepper
- Posts w/ cap

Ages:
5 - 12
years

10 - 15
Children

Top View - Safe Use Zone

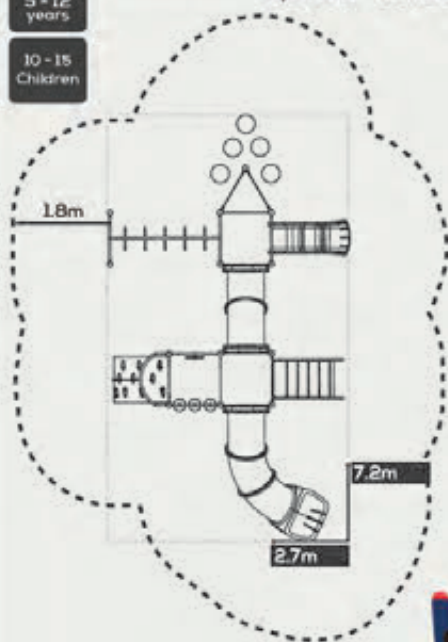

Perspective View



Perspective View

Top View - Safe Use Zone



view B.

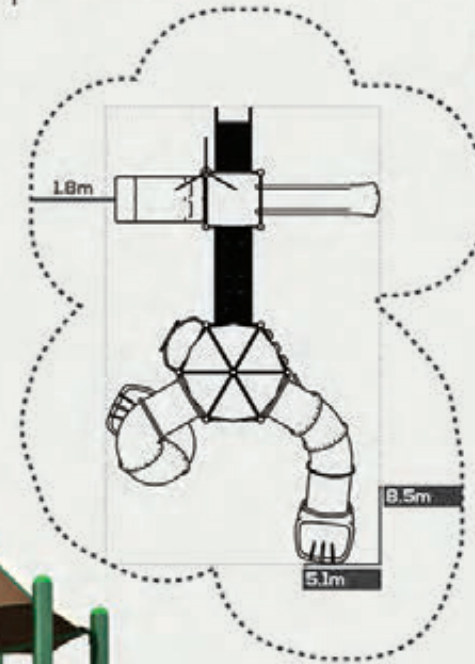

view A.

Ages:
5 - 12
years
15 - 20
Children
ASTM
Compliance

SCC18111-077

Specifications

Length : 8.5m
Width : 5.1m
Height : 4.3m

Colour scheme ● ● ● ●

Components List

- Square deck
- Triangle deck
- Entrance ladder
- Double slide
- Posts w/ cap
- Tree climber
- Safety panel
- Soujona hex roof
- Spiral tunnel slide
- Handhold
- Coconut leaf deco
- Full HDPE straight bridge
- Astro slide
- XOX panel
- Kickplate
- Movable window panel
- Banana tunnel slide



SCC17131-086A

Specifications



Length : 8.6m
Width : 6.9m
Height : 4.5m

Colour scheme ● ● ●

Components List

- Square deck
- Triangle deck
- Net cross
- Helix cross
- S-tunnel slide
- Banana Anacenda slide
- Spiral tunnel slide
- Arch loop climber
- Fireman pole
- Saga climber
- Modern clock panel
- Modern maze panel
- Modern gear panel
- Triangle roof
- Net roof
- Rung
- Handhold
- Kickplate
- FTR icon cap
- Pasts w/ cap

Ages:
5 - 12
years

15 - 20
Children

ASTM
Compliance

Top View - Safe Use Zone

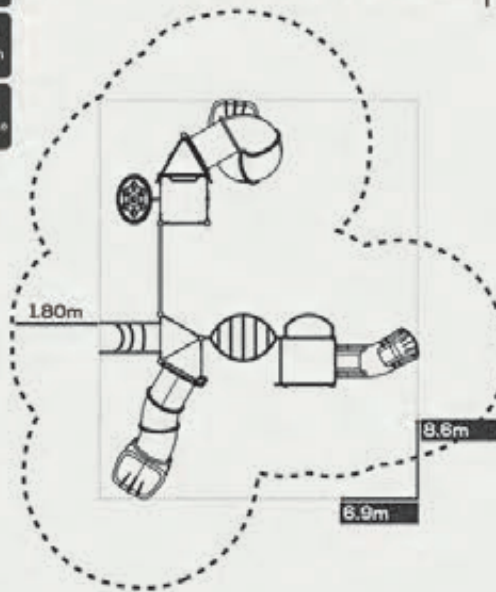

Perspective View

view B.



view A.



Come rain, snow or shine, our products are designed to withstand the outdoors. Metal parts are treated specifically to deter from the elements. If it can survive the tropical savagery, it can survive anywhere.



Location : Saigon City, Vietnam

SCC16091-174A

Specifications



Length : 4.4m
Width : 4.3m
Height : 3.5m

Colour scheme ● ● ●

Components List

- Square deck
- Triangle deck
- Quarter deck
- Balcony deck
- Transition step link
- Banana Anaconda slide
- Balcony panel
- Balcony plate panel
- Simple panel
- Spiral climber
- Panel climber
- Rock climber
- Counter panel
- Panel plate
- Ragna roof
- Posts w/ cap
- Handhold
- Kickplate
- Small circle deco
- Cloud stepper

- Ages:
5 - 12
years
- 12 - 15
Children
- ASTM
Compliance

Top View - Safe Use Zone

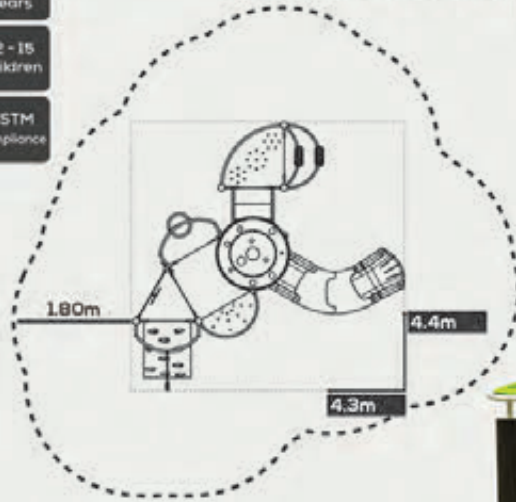

Perspective View



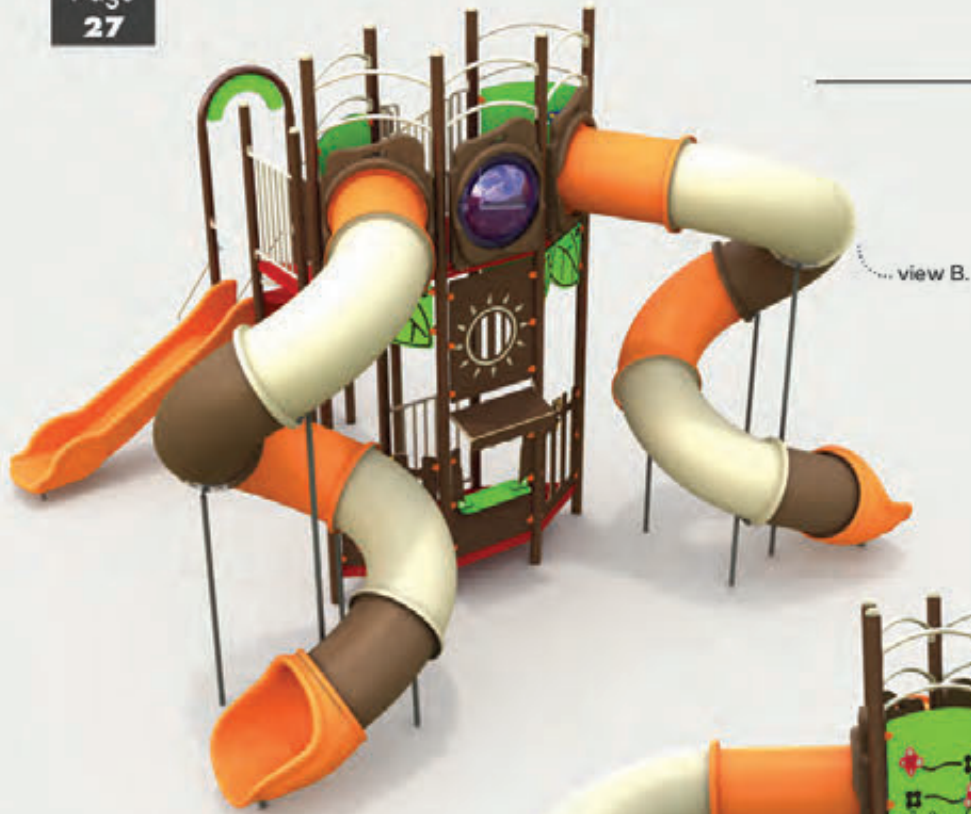

Perspective View

Top View - Safe Use Zone

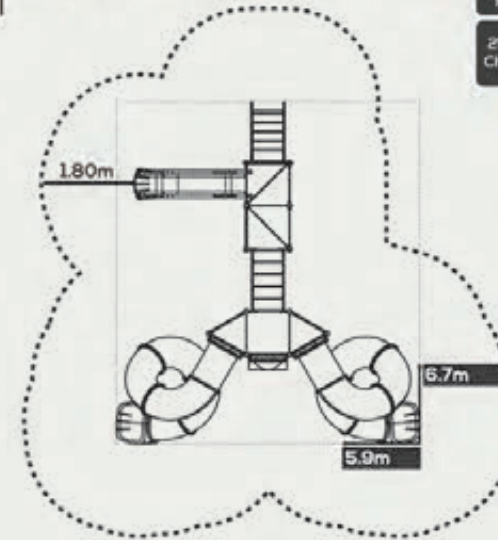

Ages:
5 - 12
years

28 - 30
Children

SCC16122-317BA

Specifications

Length : 6.7m
Width : 5.9m
Height : 4.3m

Colour scheme

Components List

- Square deck
- Step deck
- Spiral tunnel slide
- Astra slide
- Entrance ladder
- Kickplate
- Bubble panel
- Safety panel
- Gorilla face panel
- Selamat datang arch
- Arch rung
- Alphabet panel
- Sunrise panel
- Butterfly movable panel
- Awning
- Counter panel
- HDPE leaf deco w/ ladybird
- Pro Kids panel
- Castle panel w/ steering
- Safety panel



SCC18151-115

Specifications



Length : 7.0m
Width : 3.7m
Height : 3.3m

Colour scheme

Components List

- Square deck
- Entrance ladder
- Mini Astro slide
- Castle window panel
- Elevated net cross climber
- Shrub deco
- Shrub deco w/ duck and cow deco
- Straight crawlway
- Spring climber
- Kahcl slide deco
- Rock climber
- Astro slide
- Farm roof deco
- Animal deco
- Wavy flag deco
- Posts w/ cap
- Rung
- Handhold

Ages:
2 - 5
years

12 - 15
Children

ASTM
Compliance

Top View - Safe Use Zone

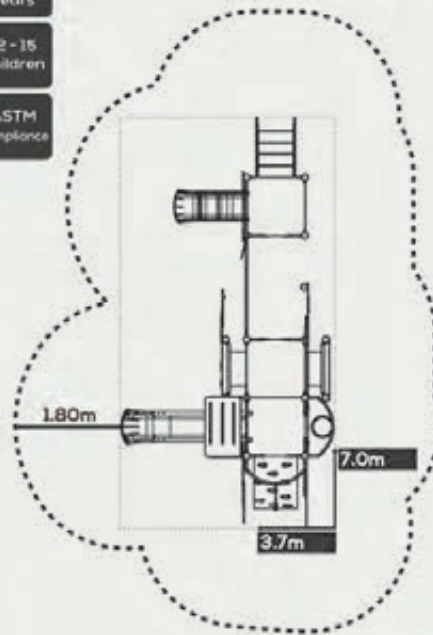

Perspective View



Do you realize that one can do so much with just a piece of flat plastic? It's such a forte in our portfolio to be good at carving plastics. It's not just normal plastics though, we use High-Density Poly Ethylene (HDPE) that resists fading and deformation. Our own CNC milling machine is able to whittle small grooves down to just 1 mm, increasing the design flexibility.

Location : Toa Payoh, Singapore



SCC16081-068A

Specifications



Length : 6.7m
Width : 4.5m
Height : 3.5m

Colour scheme ● ● ●

Components List

- Square deck
- Triangle deck
- Waja climber
- Zoom Anaconda slide
- Banana Anaconda slide
- Preve climber
- Ferium roof
- Neo roof
- BLM climber
- Inspira climber
- Posts w/ cap

Ages:
5 - 12
years

10 - 15
Children

ASTM
Compliance

Top View - Safe Use Zone

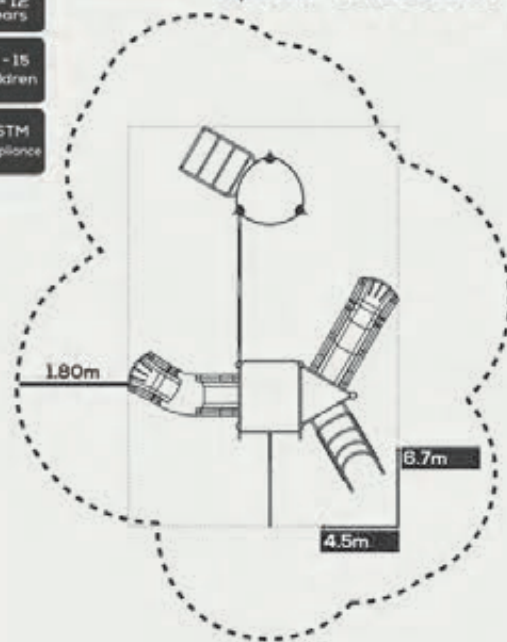

Perspective View

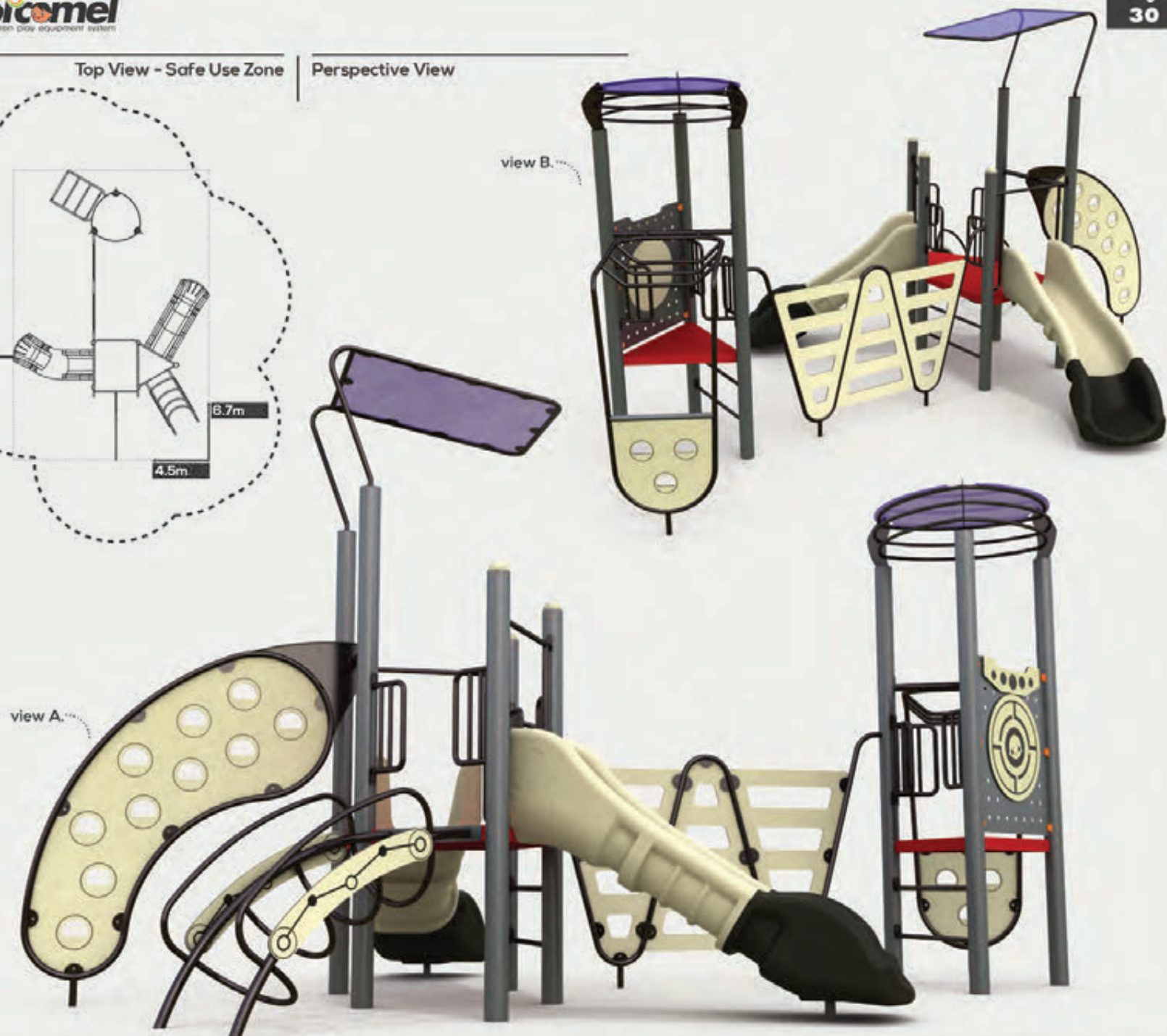



Perspective View

Top View - Safe Use Zone

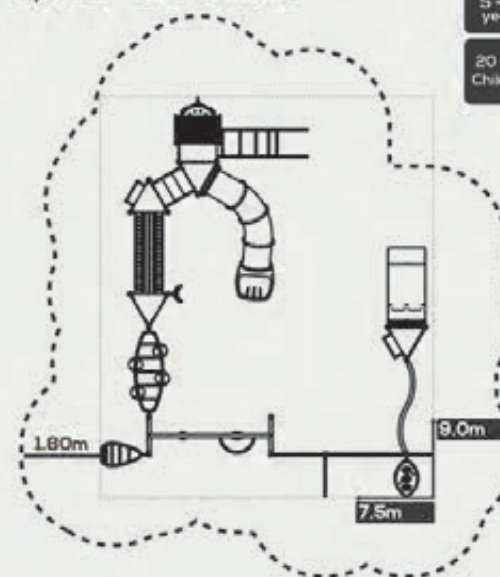

Ages:
5 - 12
years

20 - 25
Children

SCB17202-114BA

Specifications

Length : 9.0m
Width : 7.5m
Height : 3.6m

Colour scheme ● ● ●

Components List

- Square deck
- Triangle deck
- Balcony deck
- Deck extension
- Rock climbing wall
- Challenger climber
- Log bridge
- Ellipse wobble ladder
- Duo Ellipse Spinning cross
- Sitorgaser climber
- Single hanging ring
- Slope ladder
- Inline climber
- HDPE climber
- wobble link climber
- Transition step link
- S-balancing beam
- Safety panel
- Double slide
- Rung
- Vertical ladder
- Kickplate
- Pests w/ cap
- Handhold
- Ellipse loop climber
- Slurpy roof
- Safety panel
- Banana tunnel slide



view A.



SCB18172-117

Specifications



Length : 7.5m
Width : 7.3m
Height : 3.9m

Colour scheme ● ● ●

Components List

- Square deck
- Triangle deck
- Balcony deck
- Challenger climber
- Vertical rock climber
- Gear panel
- S-balancing beam
- Stargazer climber
- Wobble ladder
- Caterpillar cross
- Astra slide
- Vertical ladder
- Horizontal loop ladder
- Double slide
- Mini Astra slide
- Rope climbing
- Cyber Moon roof
- Transition step link
- Safety ball
- Safety panel
- Kickplate
- Posts w/ cap

Ages:
5 - 12
years

15 - 20
Children

Top View - Safe Use Zone

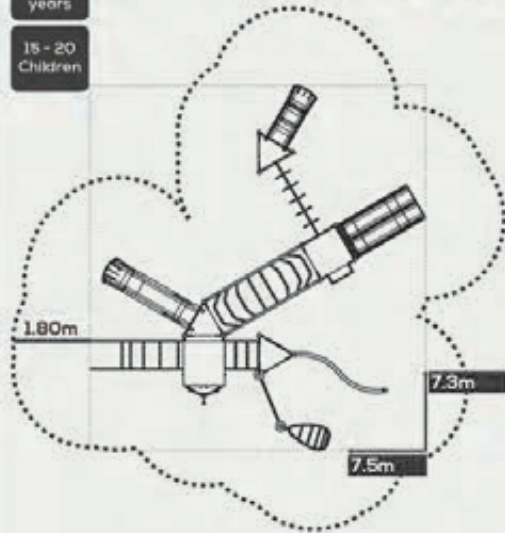

Perspective View





Perspective View

Top View - Safe Use Zone

view B.

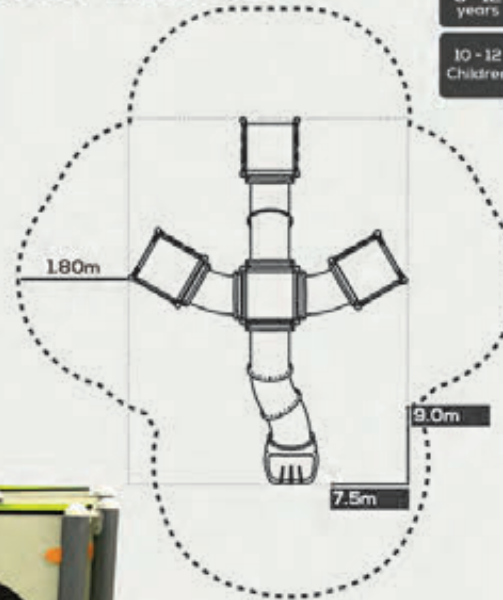

view A.

Ages:
5 - 12
years

10 - 12
Children

SCC18162-116

Specifications

Length : 5.6m
Width : 4.8m
Height : 3.2m

Colour scheme

Components List

- Square deck
- Banana Anaconda slide
- HDPE hole climber
- Musical slotted panel
- Elevated crawlway
- Curved tube crawlway
- Posts
- Window panel
- Arch panel
- Musical slotted roof panel
- Musical bottom panel
- Handhold



SCC16122-036A

Specifications



Length : 5.7m
Width : 5.4m
Height : 2.9m

Colour scheme ● ● ● ● ●

Components List

- Square deck
- Deck extension
- Double slide
- Mini Astro slide
- Castle panel
- Small tree deco
- Elevated tunnel crawway
- Fun shape ladder
- XOX panel
- Jungle tree deco
- Rock climber
- Wood panel
- Horizontal loop ladder
- Strawberry welcome sign
- HDPE panda entrance A
- HDPE panda entrance B
- Strawberry bottom deco
- Pests w/ cap

Ages:
5 - 12
years

10 - 15
Children

Top View - Safe Use Zone

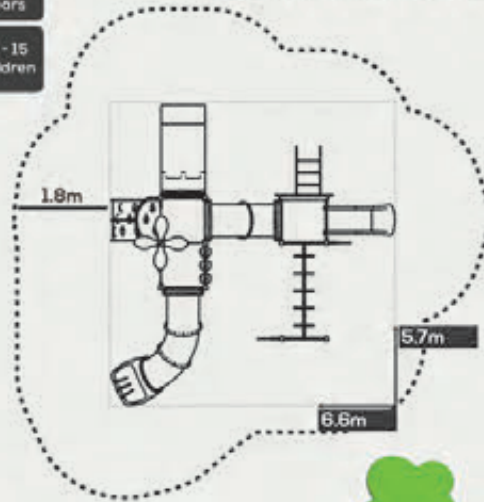

Perspective View



view B.



view A.





One glance at our playground set, you can see how we use the design to lure kids in, to come and play. And that's not a bad thing, given that the things unseen are also taken care of. Things such as the materials we use are of high quality and non-toxic. Standards-compliant raw metal with rust treatment, and entrapment-proof holes and slits, nooks and crannies, all to provide the safest play environment for young precious children.

Location : Setia Alam, Malaysia

SCB18112-011

Specifications



Length : 6.6m
Width : 5.7m
Height : 3.8m

Colour scheme ● ● ● ● ● ● ● ● ● ●

Components List

- Square deck
- Step deck
- S-tunnel slide
- Spiral tunnel slide
- Mini Astro slide
- Transition step link
- Entrance ladder
- Ufo climber
- Flamingo panel
- Castle panel
- Clover roof
- Posts w/ cap

Ages:
5 - 12
years

15 - 20
Children

Top View - Safe Use Zone

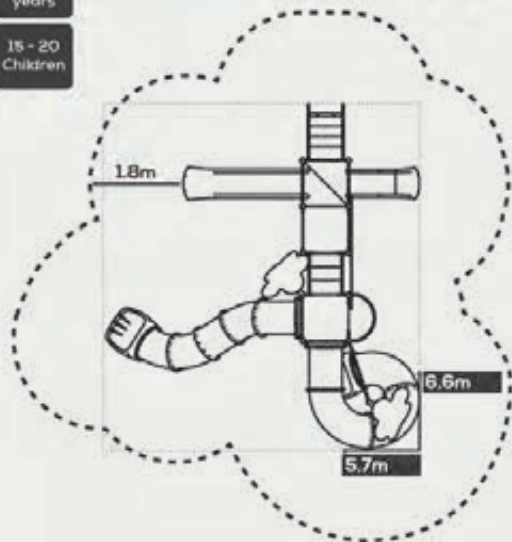

Perspective View

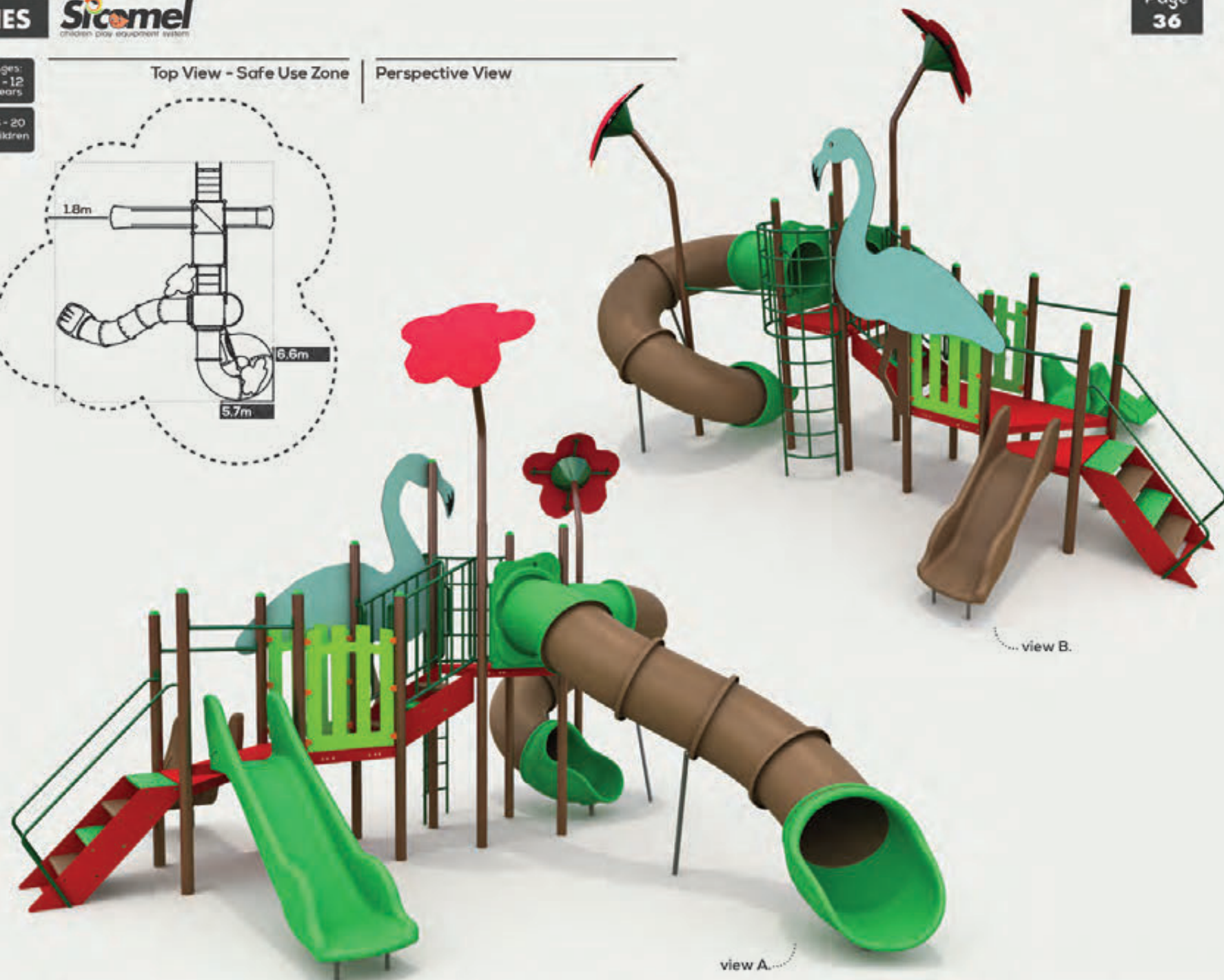



Top View - Safe Use Zone

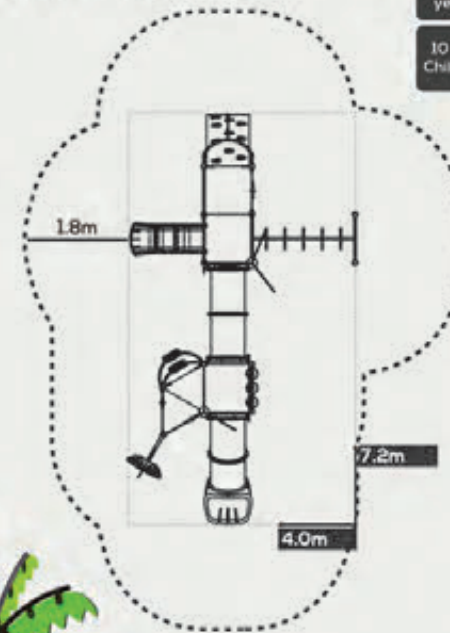

Ages:
5 - 12
years

10 - 15
Children

SCC16142-033A

Specifications

Length : 7.2m
Width : 4.0m
Height : 3.2m

Colour scheme ●●●●●

Components List

- Square deck
- Triangle deck
- Zoom tunnel slide
- XOX panel
- Parrot head panel
- Hummingbird deco
- Cloud stepper
- Straight tunnel crawlway
- Horizontal loop ladder
- Coconut leaves deco
- Castle panel w/ steering
- Interior vertical ladder
- Mini Astra slide
- Owl deco type A
- Owl deco type B
- Owl deco type C
- Handhold
- HDPE owl entrance
- Kickplate
- Posts w/ cap
- Rock climber



SCC18121-120

Specifications



Length : 6.6m
Width : 5.2m
Height : 3.4m

Colour scheme ● ● ●

Components List

- Squire deck
- Wave slide
- Entrance panel
- Flower window panel
- Slatted window panel
- T-tube crowway
- Star roof
- Tree climber
- Rock climber
- Net cross
- Compass panel
- Astra slide
- Rung
- Handhold
- Slatted steering panel
- Chime panel
- Awning deck

Ages:
5 - 12
years

15 - 20
Children

ASTM
Compliance

Top View - Safe Use Zone

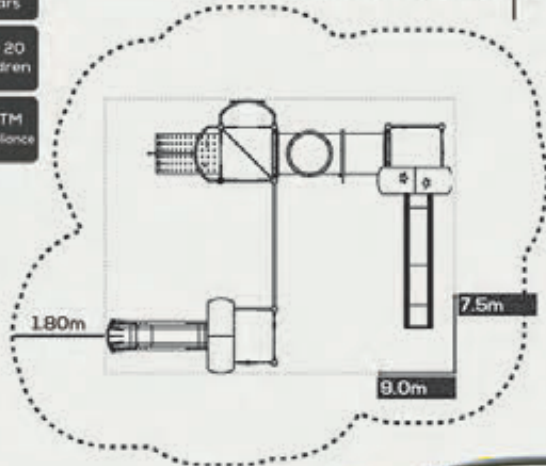

Perspective View



The T-tube is a crawlway tube with intersections, that allow more tubes to be connected perpendicularly or simply pointing up to let sunlight in. At the moment, Pro-Landscape Structure is the only local manufacturer carrying this design. Opt for the T-tube to be included in your playground set next time you drop us an inquiry.

Location : Yio Chu Kang, Singapore

SCB17171-193

Specifications



Length : 7.6m
Width : 7.7m
Height : 4.3m

Colour scheme ● ● ●

Components List

- Square deck
- Triangle deck
- Posts w/ cap
- Mini roof
- Spiral climber
- Suspended net bridge
- Transition step link
- Saujana hex roof
- Flush post cap
- Entrance panel
- Astra slide
- Net climber
- Handhold
- Tree climber
- Banana Anaconda slide
- Wave slide
- Slotted window panel
- Slotted butterfly panel
- XOX panel
- Counter panel w/ swing

Ages:
5 - 12
years

25 - 30
Children

ASTM
Compliance

Top View - Safe Use Zone

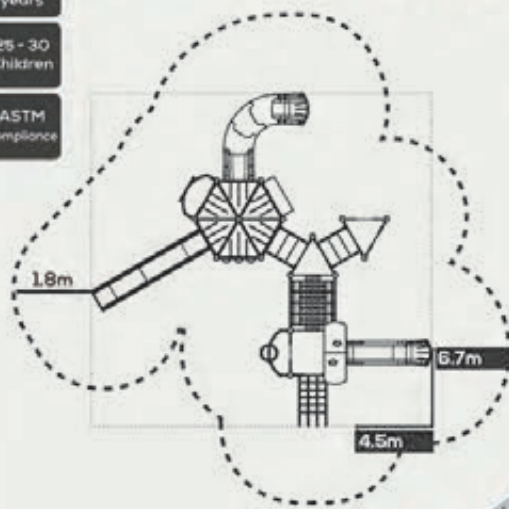

Perspective View





Perspective View

Top View - Safe Use Zone

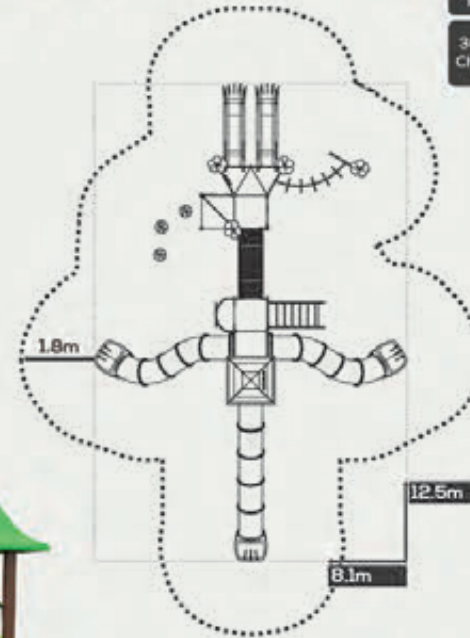

Ages:
5 - 12
years

30 - 35
Children

SCC16192-316A

Specifications

Length : 12.5m
Width : 8.1m
Height : 4.5m

Colour scheme ● ● ●

Components List

- Square deck
- Triangle deck
- Step deck
- Astra slide
- S-tunnel slide
- Zoom tunnel slide
- Elevated wave bridge
- Curved loop ladder
- Arch rung ladder
- Entrance ladder
- Tree climber
- Nationalism panel
- Steering panel
- Counter panel
- Ecosystem panel
- Slotted fauna panel
- Lotus stepper
- Handhold
- Kickplate
- Rung
- Genius roof
- Flower deco
- Posts w/ cap



view A.



CONCEPTUAL PLAYGROUNDS & PLAYSCAPES

Modular playgrounds integrated into themed playscapes.
Weaving in storylines into normal play.

LOCATION

Suasana Lumayan - Cheras, K.L

PRODUCT INNOVATION

A car and a truck bodyshell, and a bike's chassis made usable again as parts of playable components in the whole playground area.



TITLE : THE RIDE TO THE LOST FOREST

Why settle with regular playgrounds? Children's physiology and cognitive functions develop better when their brains are prodded with new stimulants every now and then. Such stimulants can come in from their play environment they're engaging in. Hence, it's our call as the playground manufacturer to bring forth something more than regular, like this playscape. Explore more possibilities in the coming pages where ideas know no boundaries.



Jump out of the aquarium and right into the open space. Every element from the habitat of the guppy fish, or *ikan gapi*, is bigger and closer to interact with, play with, and learn from. Sculpted from a variety of quality plastics, acrylics, ropes, and natural wood, this custom playscape is an adventure galore bathed in an inviting colour scheme, that's sure to reel in a bunch of happy explorative kids.

IKAN
GAPI

A showcase of a complete butterfly metamorphosis phases should not be kept in glass cases, but laid out in the open to be interacted with in the form of various play activities. It's a great way for children to spread their metaphorical wings and explore the wonderful world of science.

Butterfly Metamorphosis Playscape



The rendering is an artist's impression only. Actual specifications may vary and colours displayed are subject to availability.



**THE
SWAMP**
playscape

NIGHT

DAY

The eeriness of the deep dark nights at a remote swamp usually doesn't go together with the fun nature of a typical playground. But then, this concept is anything but typical. Sprinkles of LED lighting and luminous glow in the dark paints brighten up the nights so that there's plenty of fun to be had long after the sun is down. Effigies of mangrove roots, rotten driftwoods, sunken boats, and the terrifying glowing green alligator, are combined to create a realistic atmosphere so spooky it's fun to play in.

These renderings are artist's impressions only. Actual specifications may vary and colours displayed are subject to availability.

Nature is not a place to visit. It is home. Wave the kids to come home to play in the midst of greenery where the air doesn't choke those delicate little lungs. If you vision an open space like this, this playground concept will fit just nicely preserving the surrounding landscape with such balance of earthy colours and natural elements in its design.



pondok &
treehouse

These renderings are artist's impressions only. Actual specifications may vary and colours displayed are subject to availability.

Soaking Wet

An interesting reaction can be observed when kids are exposed to a chemical compound called Dihydrogen Monoxide. The heart rate goes up, endorphine level increases, they are less perceiving of the vital nociception their little bodies are trying to tell. Too much exposure can also cause the skin at their fingertips to wrinkle. These are the symptoms scientists call, having fun.

Waterplay equipment.
Specifications and details on pages 80 to 87

Candyland

Craving for some sweet and delicious fun?
This is the only playground concept made from
SUGAR, SPICE, AND EVERYTHING NICE!



The Candy Play House.
Specifications and details on page 12

These renderings are artist's impressions only. Actual specifications may vary and colours displayed are subject to availability.

No alien abduction, no human subjected to complex physical and psychological procedures, just an extreme and otherworldly challenging play time.

The Giant UFO

The Giant UFO Climb.
Specifications and details on page 76

These renderings are artist's impressions only. Actual specifications may vary and colours displayed are subject to availability.

People flock in public parks to satisfy their communal and socializing needs, or simply to unwind. Any good park will receive mass visitors that include children. Life just wouldn't be complete without a good sized playground equipment to keep the town's kids happy.

Sicomel
children play equipment system

EXCLUSIVE SERIES
Integrated Playset





view B.

Perspective View

Top View - Safe Use Zone

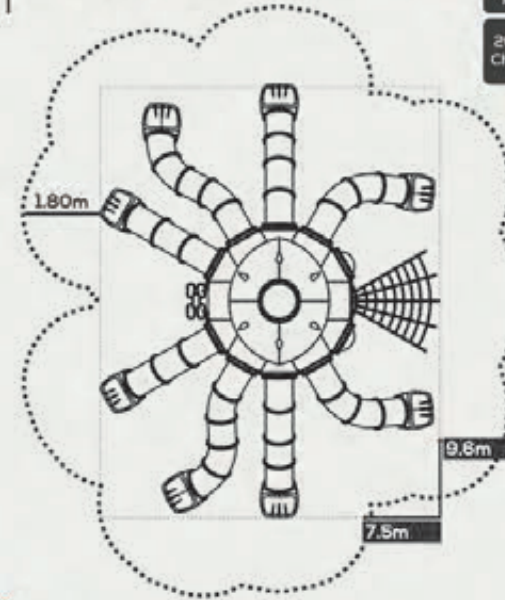

Ages:
5 - 12
years

20 - 30
Children

SCC18182-118

Specifications



Length : 9.6m
Width : 7.5m
Height : 4.3m

Colour scheme ● ● ● ●

Components List

- Square deck
- Triangle deck
- Spider climber
- Banana tunnel slide
- Zoom tunnel slide
- S-tunnel slide
- Hurly-burly climber
- Bendahara roof
- Castle panel w/ steering
- Zest panel
- Steering panel
- XOX panel
- Vertical ladder
- Rung
- Handhold
- Posts w/ cap
- Cyber HDPE deco

view A.



SCB17232-057BA

Specifications



Length : 8.6m
Width : 8.0m
Height : 4.6m

Colour scheme ● ● ●

Components List

- Square deck
- Triangle deck
- Step deck
- Balcony deck
- Balcony panel
- Slurpy roof
- Interior vertical ladder
- XOX panel
- Rung
- Handhold
- Compass panel
- Double slide
- Wave bridge
- Movable racing car panel
- Zoom tunnel slide
- Movable butterfly panel
- Posts w/ cap
- Bubble panel
- Arch rung
- Rock climber
- Castle panel
- Spiral tunnel slide
- Tree climber
- Creek roof
- Zest panel
- Anaconda slide
- Kickplate
- Vertical ladder
- Clock panel
- Education park panel
- Si-comel panel
- Pry-kids panel

Ages:
5 - 12
years

20 - 25
Children

Top View - Safe Use Zone

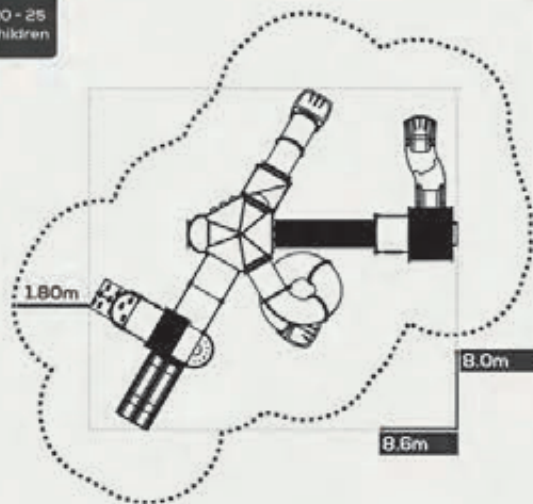

Perspective View



view B.



view A.





Perspective View

Top View - Safe Use Zone

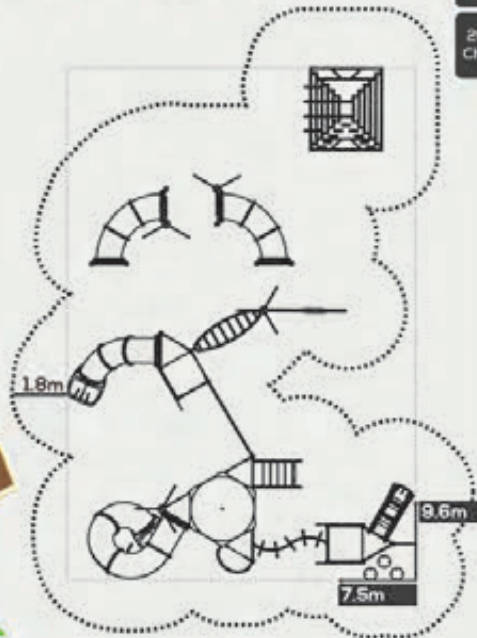

Ages:
5 - 12
years

20 - 25
Children

SCC16292-307A

Specifications

Length : 9.6m
Width : 7.5m
Height : 4.3m

Colour scheme ● ● ● ●

Components List

- Square deck
- Triangle deck
- S-loop ladder
- Mini Astra slide
- Pyramid climber
- Entrance ladder
- Arabian roof
- Decorative wavy climber
- Wobble link ladder
- Triangle wall climber
- Curved tube crawlway
- Banana tunnel slide
- Spiral tunnel slide
- Arabic panel
- Fireman pole
- Coconut leaf deco
- Arabic welcome panel
- Camel side body
- Camel head
- Kickplate
- Handhold
- Rung
- Pests w/ cap
- Wobble stepper



SCC16202-119A

Specifications



Length : 9.9m
Width : 7.3m
Height : 4.8m

Colour scheme ● ● ● ● ●

Components List

- Square deck
- Triangle deck
- Tube crawlway
- Varyed bridge
- Banana Anaconda slide
- Entrance ladder
- Curved trapeze rings
- Kickplate
- Spiral tunnel slide
- Candy shaped steering panel
- Counter panel
- Candy panel A
- Fun maze panel
- Fantasy hex roof
- Bubble panel
- Arch candy post
- candy racing panel
- Candy deck
- Handhold
- Rung
- Tree climber
- Vertical ladder
- Sweet candy deco
- Posts w/ cap
- Sweet candy wording

Ages:
5 - 12
years

ASTM
Certified

Top View - Safe Use Zone

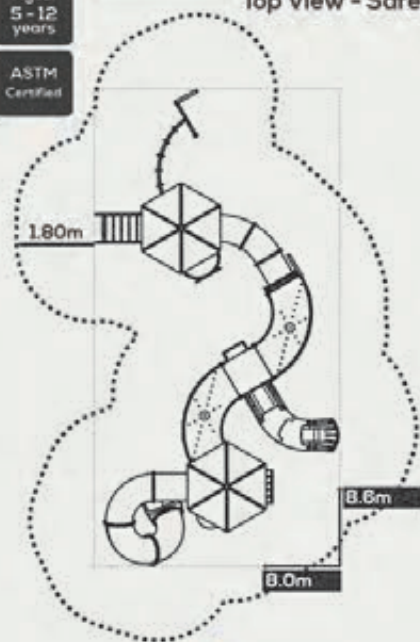

Perspective View





Because flat powder coating is too mainstream. The effect seen here is the result of multi layered airbrush coating applied to metal parts. This happens when the pressure to set out as unique is too great. No shame in that as living life being similar is as exciting as watching paint dry.

Location : Sungkai, Malaysia

SCC17292-123A2

Ages:
5 - 12
years

30 - 35
Children

Specifications



Length : 8.9m
Width : 8.3m
Height : 6.0m

Colour scheme ● ● ● ●

Components List

- Square deck
- Triangle deck
- Curved tube crawway
- Spiral tunnel slide
- Elevated crawway
- Curved monkey bar
- Cats pillar cross
- Rock climber
- Entrance ladder
- Kickplate
- Handhold
- Rung
- Steering panel
- Moose head
- XXO panel
- Miri Astra slide
- Banana Anaconda slide
- Bubble panel
- Moose side body
- Posts w/ cap
- Ramting discs
- Hornbill deco
- Jungle tree leaf deco
- Monstera roof
- Heliconia roof
- Telescope panel
- Vertical ladder
- Wavy climber
- Monkey face panel
- Gerilla face panel
- Arch ladder
- Tree ladder
- Wobble stepper

Top View - Safe Use Zone

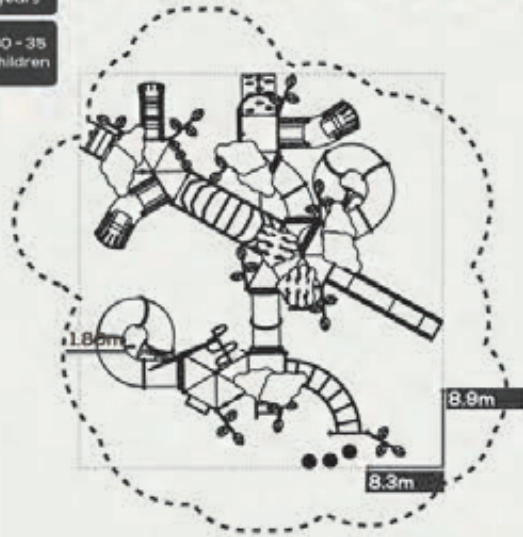

Perspective View



Perspective View

Top View - Safe Use Zone

Ages:
5 - 12
years

40 - 45
Children

SCC16222-219A

Specifications

Length : 10.4m
Width : 6.3m
Height : 5.4m

Colour scheme ● ● ● ● ●

Components List

- Square deck
- Triangle deck
- Spiral tunnel slide
- Mini Astro slide
- Mini Dome bridge w/ HDPE panel
- Entrance ladder
- Arch ladder
- Tree climber
- Wobble step
- Wobble climber
- Vertical ladder
- Interior vertical ladder
- Bubble panel
- Stripe panel
- XOX panel
- Safety panel
- Steering panel
- Modern steering panel
- Modern clock panel
- Modern gear panel
- Posts w/ cap
- Circular structural roof
- Circular structural roof Type 2
- Handhold
- Kickplate
- Rung

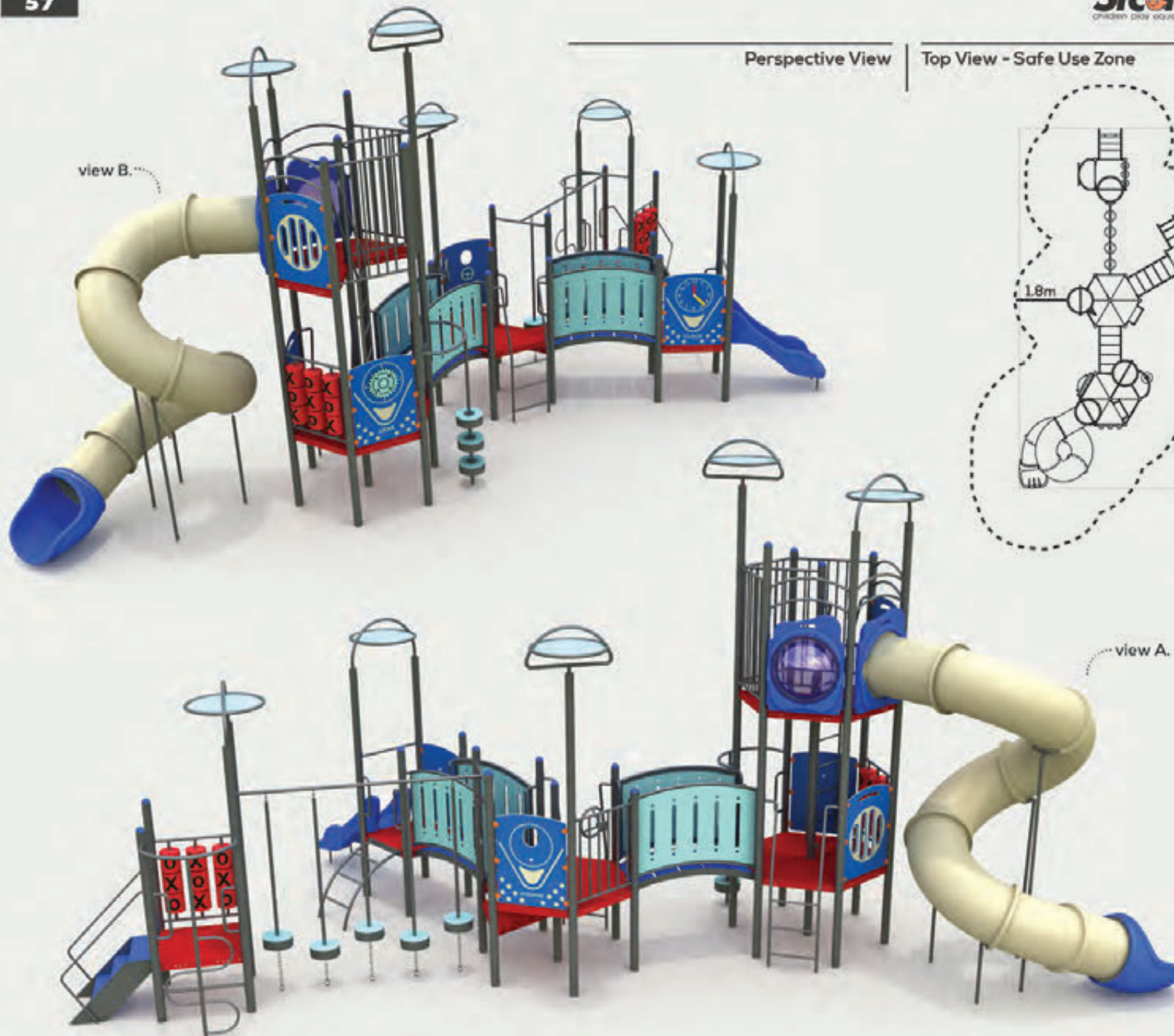

SCC16612-088A

Specifications



Length : 18.2m
Width : 14.1m
Height : 6.8m

Colour scheme



Components List

- Square deck
- Triangle deck
- S-tunnel slide
- Posts w/ cap
- Slope panel
- Skull flag
- Medium ship sail
- Small ship sail
- Arch roof
- HDPE steering panel
- Vertical ladder
- Spiral tunnel slide
- Handheld
- Spring climber
- Arch post
- Bendy dolphin deco
- Wave deco
- Telescope panel
- HDPE ship panel
- Steering panel
- Ship hull panel
- Climber panel V2
- Movable fauna panel
- Rock climber
- Jetty roof deco
- Rooster wind vane deco
- Mini Astro slide
- Kickplate
- Cloud deco
- Elevated crawlway
- Safety panel
- HDPE shark body
- HDPE shark entrance
- Wobble stepper
- XOX panel
- Ecosystem panel
- Ship panel
- Fun Cruise deco
- Pirate face panel
- Tree climber
- Small wave deco
- Seaweed deco
- Starfish deco
- Straight bridge V2

Ages:
5 - 12
years

80 - 80
Children

Top View - Safe Use Zone

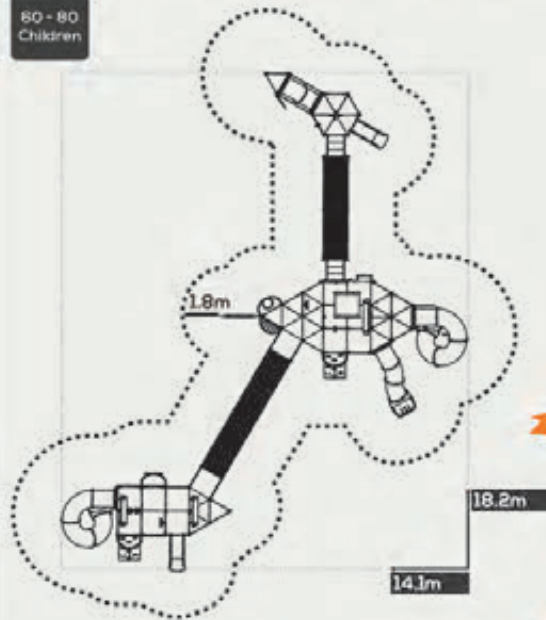

Perspective View



view B.



view A.



Slippery when wet? That won't be the case when applying our revolutionary Polytuff® coating to your deck platforms and ramps. The rubberized plastic compound engulfing the metal parts is melted at high temperature like hot cheese on lasagna, ensuring total coverage so rust will never creep in. Polytuff® coating is so hard-wearing and resilient allowing kids to scurry and scamper about without leaving behind unsightly scrapes and scratches.



Location : Temoh, Malaysia

SCC17202-092A

Specifications



Length : 9.7m
Width : 6.0m
Height : 3.6m

Colour scheme ● ● ● ●

Components List

- Square deck
- Mini Dome bridge
- Curved tube crawlway
- Banana tunnel slide
- Spiral tunnel slide
- Banana Anaconda slide
- Arch loop climber
- Vertical ladder
- Spring climber
- Panel climber
- Rock climber
- XOX panel
- Safety panel
- Bubble panel
- Circles pattern panel A
- Circles pattern panel B
- Circles pattern panel Pro-Panel
- Kickplate
- Handhold
- Silverquad roof
- Pests w/ cap

Ages:
5 - 12
years

25 - 30
Children

Top View - Safe Use Zone

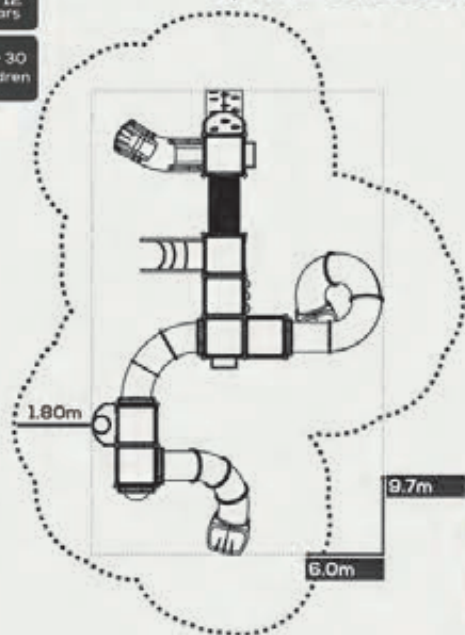

Perspective View



view A.





Perspective View

Top View - Safe Use Zone

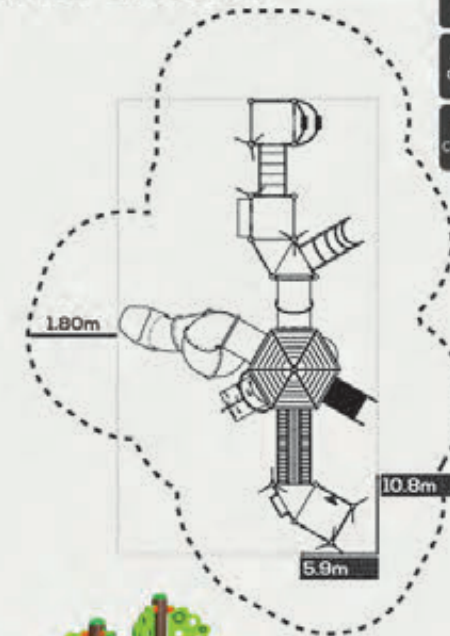

Ages:
5 - 12
years

45 - 50
Children

ASTM
Compliance

SCC16221-158A

Specifications

Length : 10.8m
Width : 5.9m
Height : 5.1m

Colour scheme ● ● ● ● ●

Components List

- Square deck
- Triangle deck
- Spiral tunnel slide
- Transition step link
- Log bridge
- Elevated crawlway
- Cloud stepper
- Rock climber
- Arch loop ladder
- Vertical ladder
- Entrance ladder
- Interior vertical ladder
- XOX panel
- Safety panel
- Steering panel
- Flower panel
- Bubble panel
- Movable butterfly panel
- Counter panel w/ awning
- Rendek dece
- Village roof
- Handhold
- Posts w/ cap



view A.



SCC17342-102A

Specifications



Length : 17.1m
Width : 8.1m
Height : 6.0m

Colour scheme



Components List

- Square deck
- Triangle deck
- Elliptical loop bridge
- Spiral tunnel slide
- Banana Anaconda slide
- Interior vertical ladder
- Kickplate
- Safety panel
- Elevated bridge
- Monkey bar
- Caterpillar crawlway
- Astro slide
- Spider web climber
- Propeller
- Semi UFO climber
- Monkey face panel
- Banana tunnel slide
- Swamp roof deco
- Small tree deco
- Movable butterfly panel
- Lion face panel
- Track ride
- Triangular flat roof
- Butterfly clock panel
- Bubble panel
- Safety panel
- Pro-Panel extension
- Kickplate
- Modern gear panel
- Modern maze panel
- Mini ladder
- Vertical ladder
- Flower step climber
- Gorilla face panel
- Handheld
- Rung
- Giraffe deco
- Posts w/ cap

Ages:
5 - 12
years

30 - 40
Children

Top View - Safe Use Zone

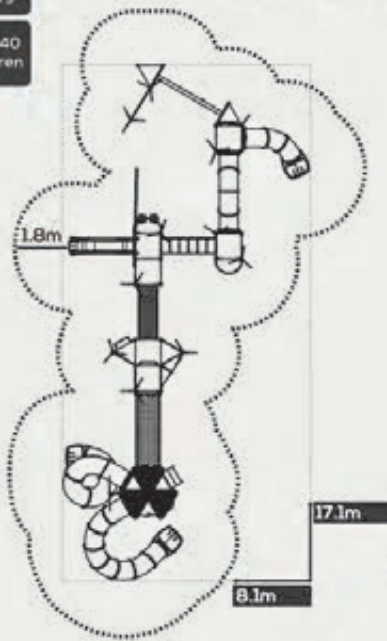

Perspective View



view B.



view A.





view B.

Perspective View

Top View - Safe Use Zone

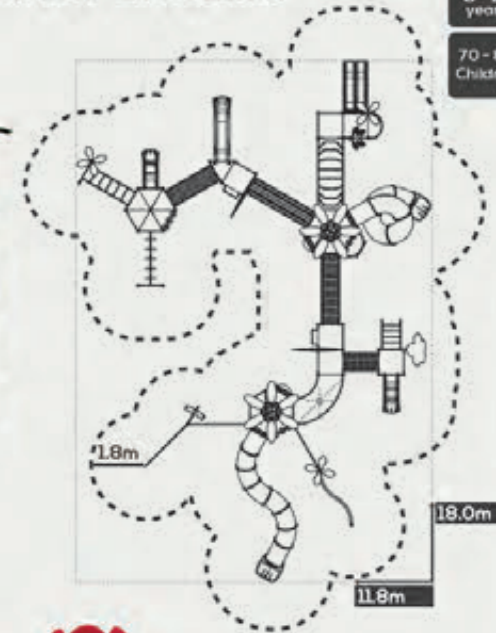

Ages:
5 - 12
years

70 - 80
Children

SCB17492-140A

Specifications

Length : 18.0m
Width : 11.8m
Height : 4.6m

Colour scheme

Components List

- Square deck
- Triangle deck
- Astra slide
- Double slide
- Mini Astra slide
- S-tunnel slide
- Interior vertical ladder
- Decorative arch climber
- Decorative wavy climber
- Horizontal loop ladder
- S-balancing beam
- Vertical ladder
- Entrance ladder
- Circle challenge
- Caterpillar cross
- Fireman pole
- Tree climber
- Monkey bar
- Log bridge
- Curved bridge
- Straight bridge
- Mini Dome bridge
- Movable butterfly panel
- Butterfly face panel
- Flower face panel
- Bubble panel
- Safety panel
- Gear panel
- Zeit panel
- XOX panel
- Handhold
- Kickplate
- Rung
- Arch rung
- Butterfly deco
- Dragonfly deco
- Jungle leaf deco
- Cassia hex roof
- Heliconia roof
- Clover roof
- Posts w/ cap



view A.



Life itself is a risk. Including certain challenge into children's play is the best way to introduce risk to kids to shape them to be better prepared for the future. So, face it helicopter parents, kids need challenge. But fret not, our CHALLENGE SERIES offer as much challenge as the amount of safety considerations built into it to let kids explore freely.

Sicomel
children play equipment system

CHALLENGE SERIES

Integrated Playset

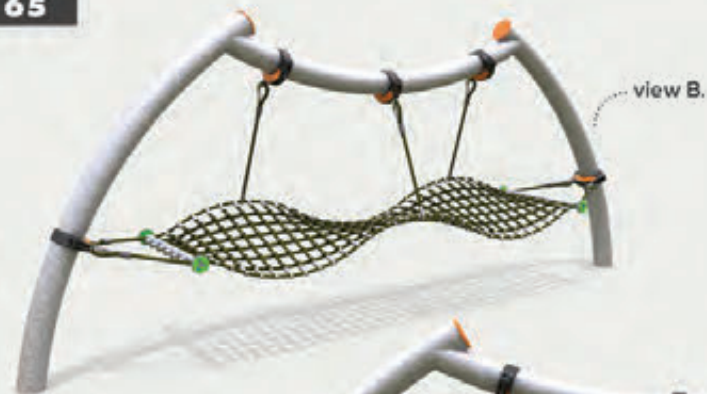

Perspective View

Top View - Safe Use Zone

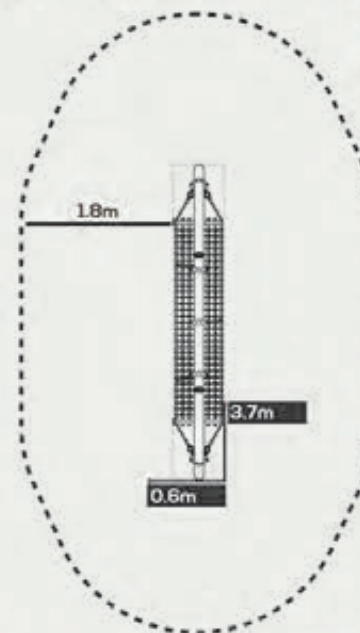

Ages:
5 - 12
years

5 - 10
Children

ASTM
Compliance

NEPTUNE PLAYNET

Specifications

Length : 3.7m
Width : 0.6m
Height : 1.5m

Colour scheme ●

Components List

Twisty mesh of rope
Metal structure

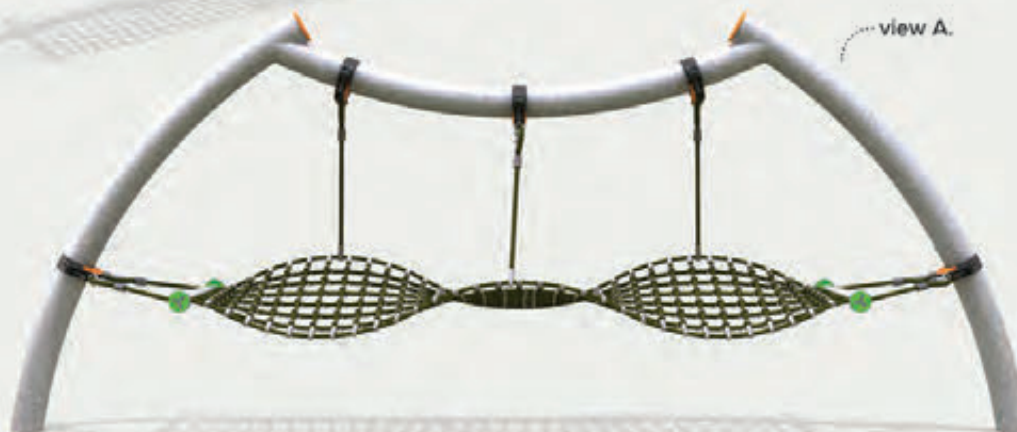

Perspective View

Top View - Safe Use Zone

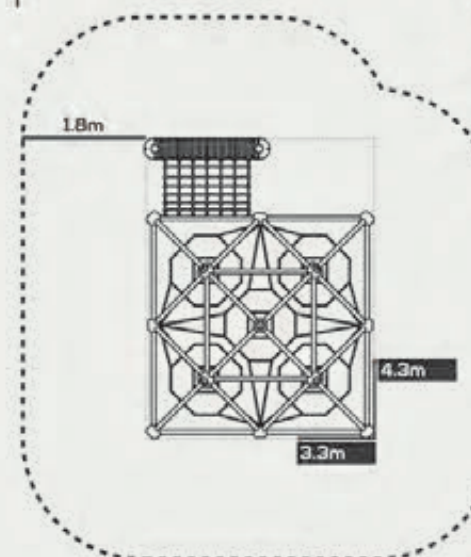

Ages:
5 - 12
years

10 - 15
Children

ASTM
Compliance

SHOOTING JUPITER

Specifications

Length : 4.3m
Width : 3.3m
Height : 3.4m

Colour scheme ● ●

Components List

Posts c/w cap
Net climber
Mini deck platform
Metal structure
Interior net webbing

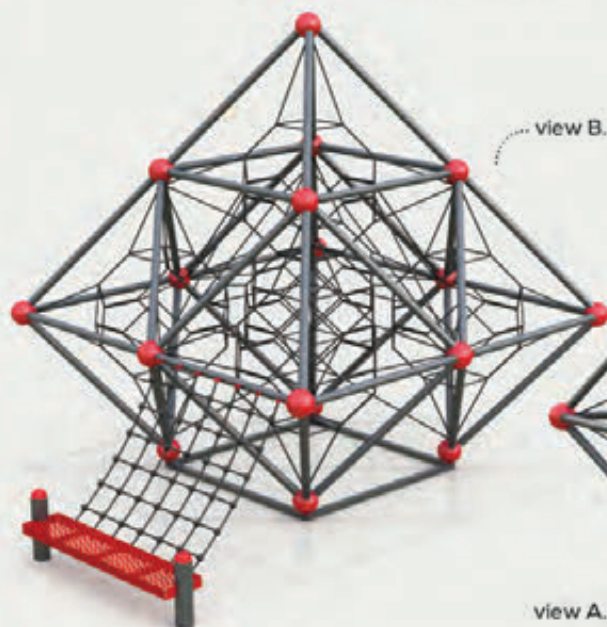

view A.

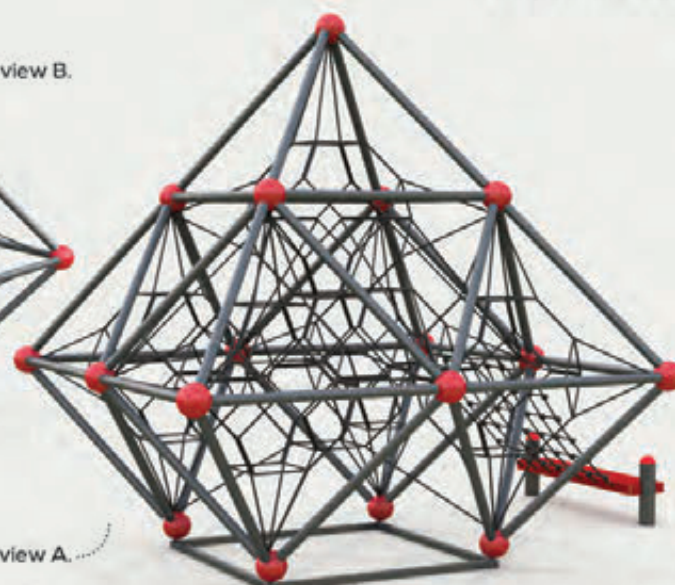

CURVENETS

Specifications



Length : 3.5m
Width : 4.0m
Height : 3.2m

Colour scheme ● ●

Components List

- Curvenet structure
- Base netting
- Slope climber
- Hammock
- End tier netting
- Top tier netting

Ages:
5 - 12
years

20 - 25
Children

ASTM
Compliance

Top View - Safe Use Zone

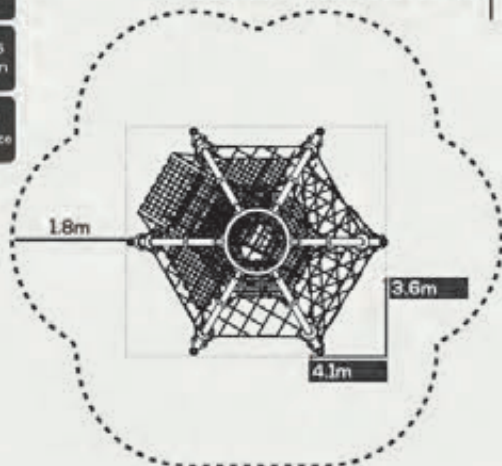

Perspective View

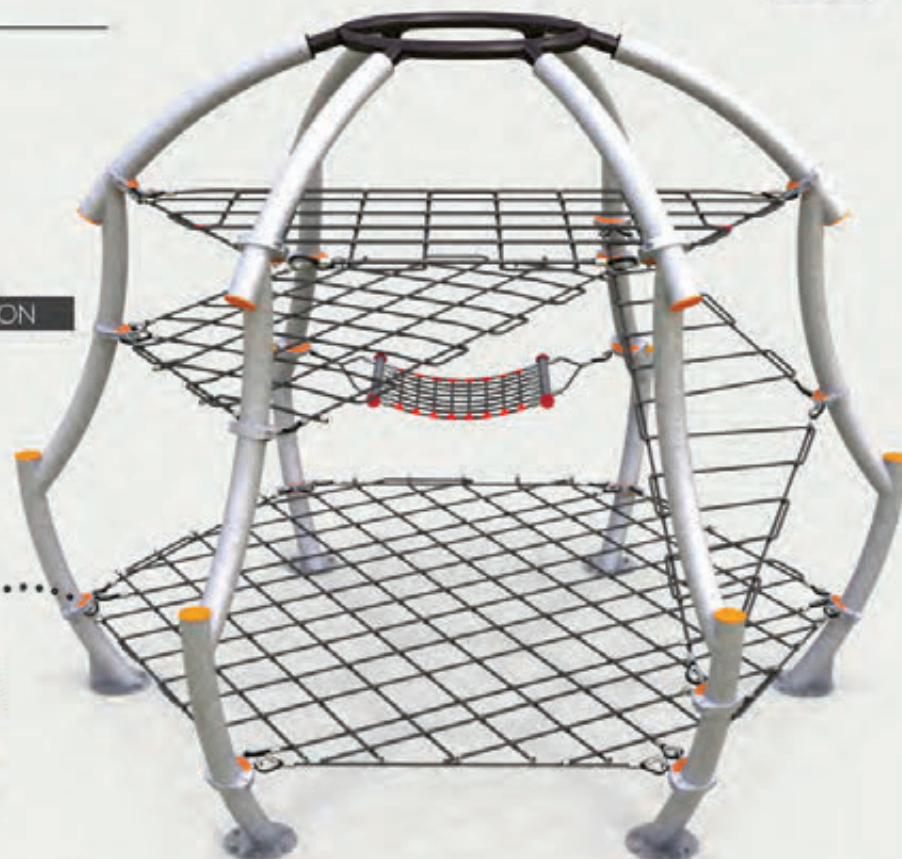

PREMIUM COMBINATION

PLAYNETS CLAMP SYSTEM

The innovative clamping system allows for myriad of rope attachment possibilities while also reducing costs. Staunch grip provided by solid aluminium construction that is designed with aesthetics in mind.



Colour option ● ●



Colour option ● ●



Colour option ● ●

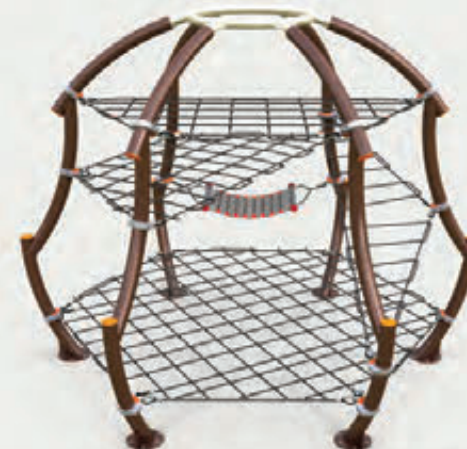

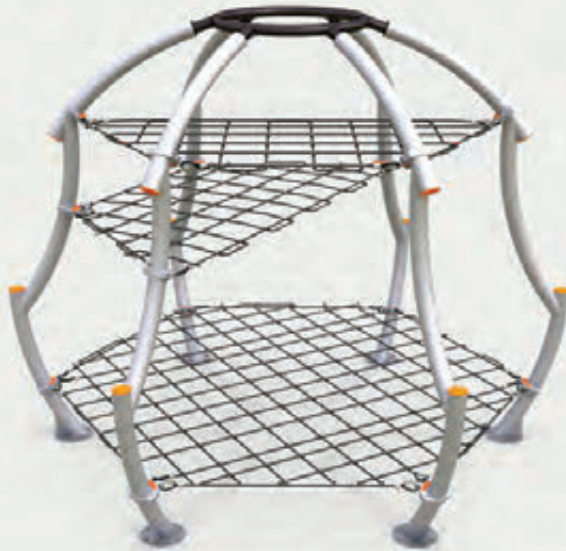

COMBINATION OPTION 1



COMBINATION OPTION 2



COMBINATION OPTION 3

OPTIONS

The Curve net is a modular play structure. As a complete set, it includes all 3 tiers of netting, a sloping climber, and a hammock.

Being modular, customizing is possible. Whether to include everything or omit something, or even colour choices, all are totally up to your preferences.

Netting Accessories



SLOPE CLIMBER



HAMMOCK



2ND TIER NETTING

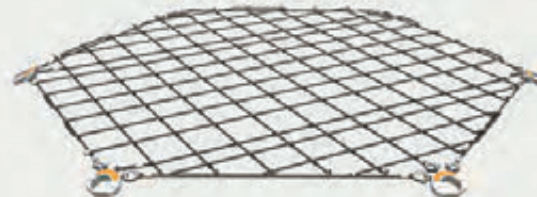

BASE NETTING



TOP TIER NETTING

SLANET 2

Specifications



Length : 7.9m
Width : 6.5m
Height : 3.3m

Colour scheme ● ●

Components List

Spiral tunnel slide
Wave slide
Rope net climber
Swinging vines climber



Ages:
5 - 12
years

10 - 15
Children

ASTM
Compliance

Top View - Safe Use Zone

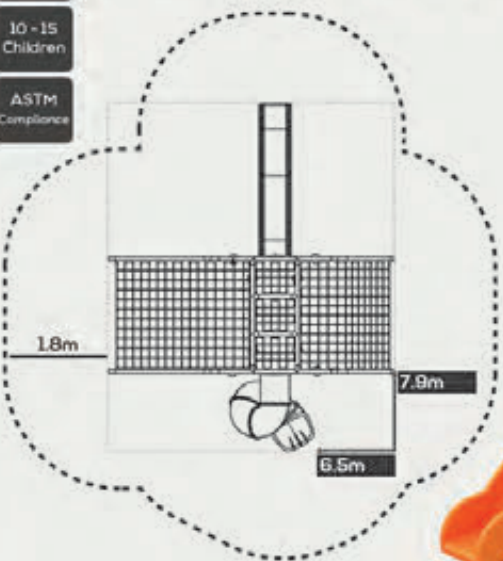

Perspective View



SCC18191-012A

Specifications



Length : 12.4m
Width : 7.3m
Height : 2.4m

Colour scheme ● ● ● ●

Components List

Triangle deck
Stargazer climber
Posts w/ cap
Ellipse loop climber
Ellipse wobbly ladder
Single spinning ellipse cross
Wire rope bridge
Single swivel cross
Circular spider web cross
Circle challenge
Helix cross
Monkey bar
HDPE climber
Brick climber
S-balancing beam
Wobble stepper
Slope ladder
Slanted beam



Ages:
5 - 12
years

25 - 30
Children

ASTM
Compliance

Top View - Safe Use Zone

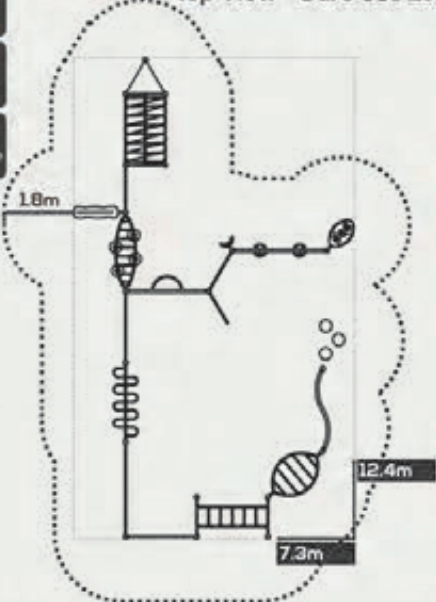

Perspective View



Perspective View

Top View - Safe Use Zone



view B.

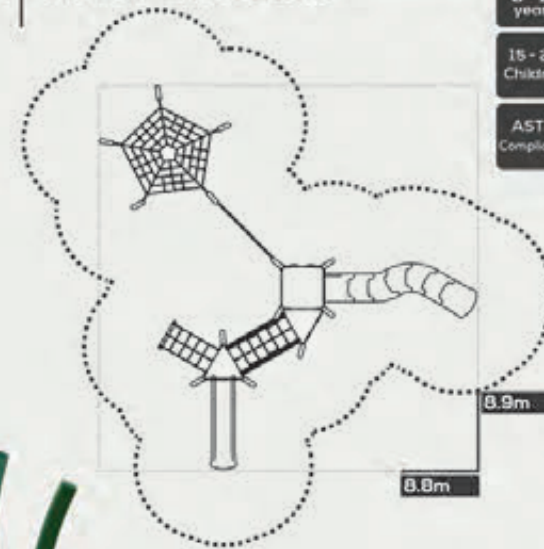

Ages:
5 - 12
years

15 - 20
Children

ASTM
Compliance

SCC18131-073

Specifications

Length : 8.9m
Width : 8.8m
Height : 5.3m

Colour scheme ● ● ● ● ●

Components List

- Square deck
- Triangle deck
- Post c/ w cap
- Long post deco
- Handrail
- Slanted net climber
- HDPE climber
- S ensenvis slide
- Slanted web net
- Elevated rope cross
- Butterfly movable panel
- Butterfly face panel
- Kickplate
- Circular spider cross
- Astra slide

view A.



CLIMBING BLOCKS

Specifications

Length : 3.7m
Width : 2.6m
Height : 3.0m

Colour scheme

Components List

Frame structure
HDPE pentagon block face
HDPE climber grip
Tree climber



Ages:
5 - 12
years

10 - 15
Children

Top View - Safe Use Zone

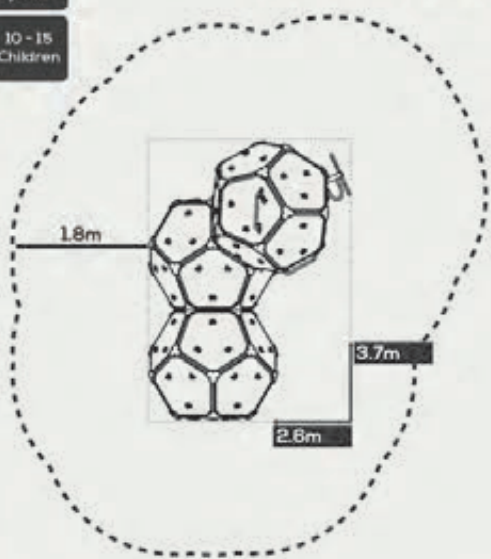

Perspective View

The Climbing Blocks started life as a ball of 12 sided pentagon faces. Whether you want it to remain it at that, or you can connect many number of individual balls together up to a maximum number that your circumstances permit. The ball is in your court.

3 Blocks.

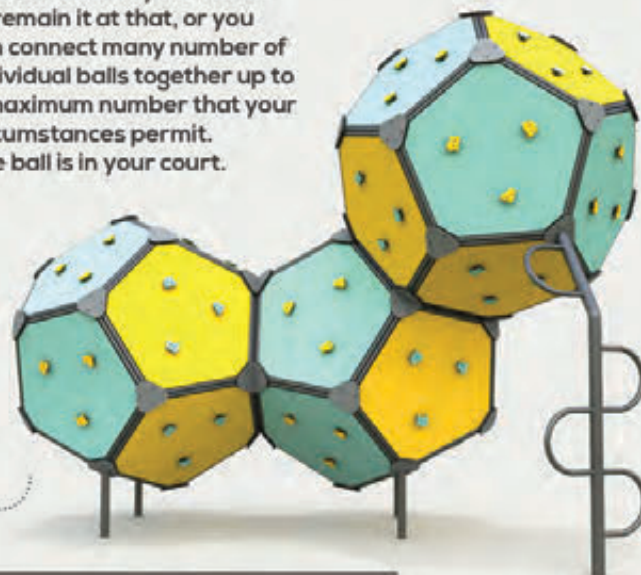

Single Block.

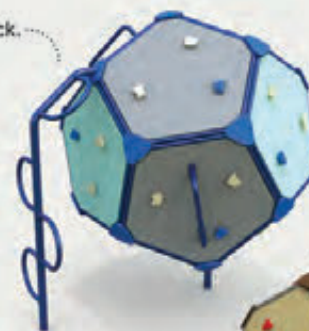

2 Blocks.



GEOMETRIC CLIMBER

Specifications

Length : 5.5m
Width : 1.1m
Height : 2.8m

Colour scheme

Components List

HDPE hexagon climber
Hexagon web rope climber
Anaconda slide
A-guard rail



Ages:
5 - 12
years

5 - 10
Children

ASTM
Compliance

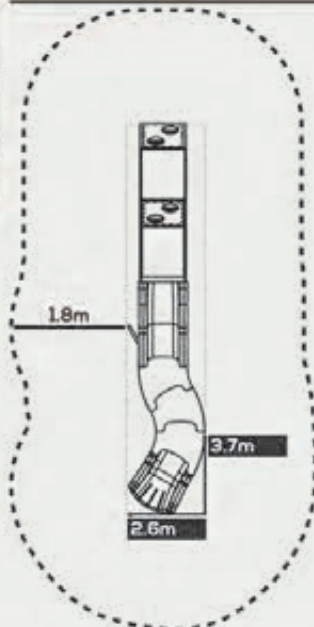

view B.



view A.

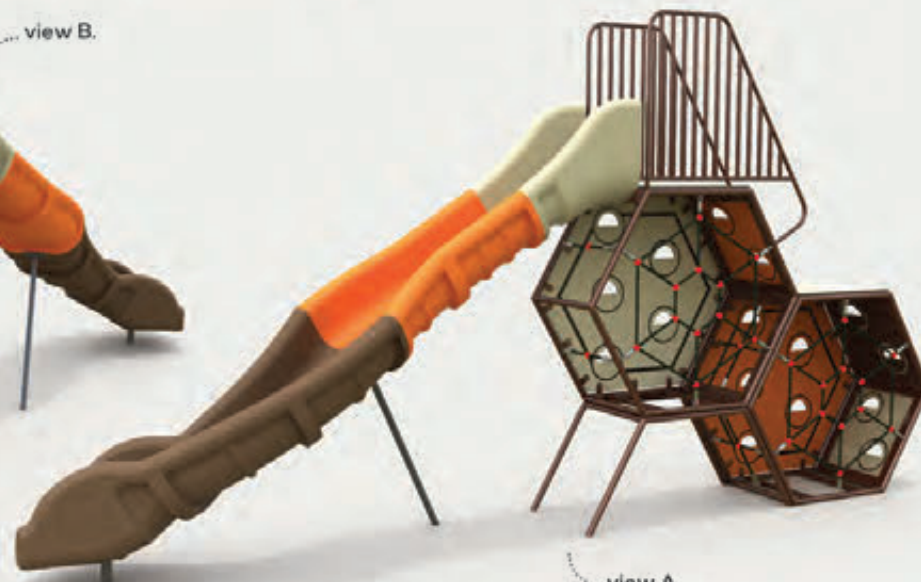

Climbing is something instinctive that children do and it is part of their development and growth. Climbing allows children to improve their coordination and motor skills. This can be through improved fitness levels, spatial and directional awareness as well as balance and agility. Products like The Climbing Blocks aim to tackle precisely this part of a child's development.

Location : Shah Alam, Malaysia

MINI LIBIRINH

Specifications

Length : 4.8m
Width : 3.6m
Height : 3.0m

Colour scheme ● ● ●

Components List

- Pillar A
- Pillar B
- Mesh frame
- S-tube slide
- HDPE panel cover
- Inclined platform
- Climbing nets
- Climbing stones
- Mesh roof
- Mesh climber
- Flat platform
- Handholds as ladder
- Flat rung

Ages:
5 - 12
years

15 - 20
Children

Top View - Safe Use Zone

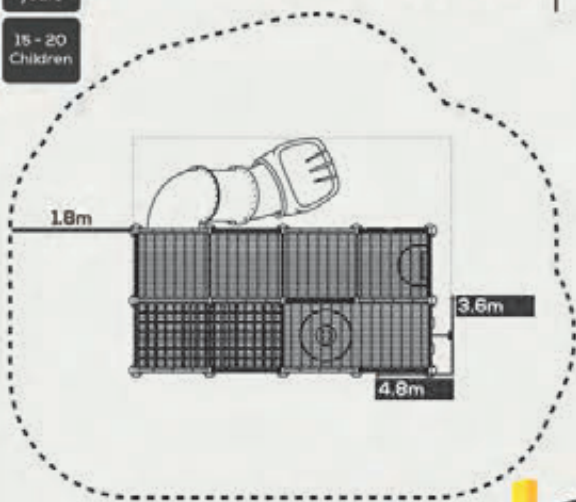

Perspective View



view B.



view A.



Put a person in an enclosed area and naturally the brain will figure out the need to set free. That's the sort of challenge presented by this towering cage. It sets the mind to explore the way out, testing problem solving skills and physical strength at the same time.

Location : Johor Bahru, Malaysia



LIBIRINH CELL v2.2

Specifications



Length : 8.3m
Width : 4.3m
Height : 4.8m

Colour scheme ● ● ●

Components List

- Pillar A
- Pillar B
- Mesh frame
- T-tube crawlway
- S-tube slide
- Wobble climber
- Tree climber
- Inclined crossbeam
- Inclined platform
- Climbing nets
- Climbing stones
- Mesh roof
- Mesh climber
- T-tube climber
- Flat platform
- Pillar box
- Handholds as ladder
- Flat rung

Ages:
5 - 12
years

20 - 25
Children

Top View - Safe Use Zone

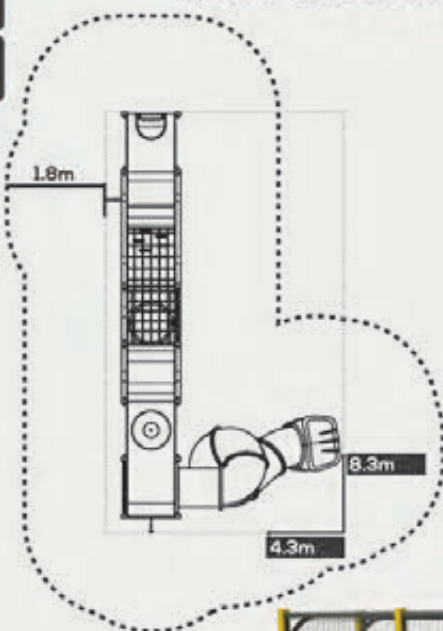

Perspective View



view B.



view A.



Perspective View

Top View - Safe Use Zone

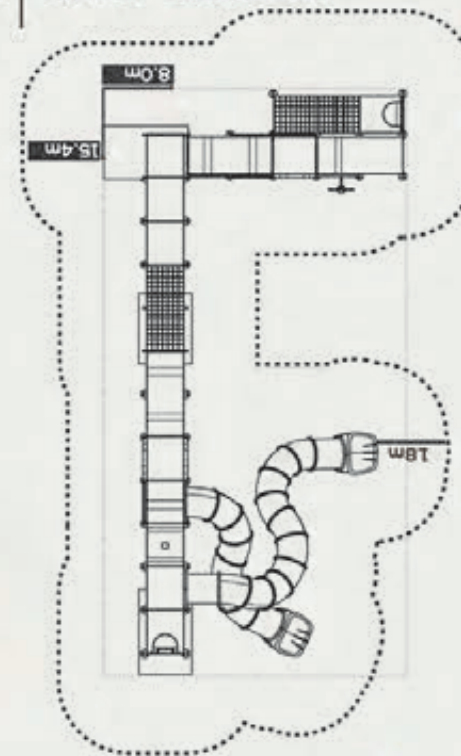

Ages:
5 - 12
years

70 - 75
Children

MEGA LIBIRINH

Specifications

Length : 15.4m
Width : 8.0m
Height : 5.4m

Colour scheme ● ● ●

Components List

- Pillar A
- Pillar B
- Mesh frame
- Platform 44
- Square box
- Middle square box
- T-tube crawlway
- S-tube slide
- Wobble climber
- Tree climber
- Inclined crossbeam
- Inclined platform
- Climbing nets
- Climbing stones
- Mesh roof
- Mesh climber
- T-tube climber
- Flat platform
- Pillar box
- Handholds at ladder
- Flat rung



view A.

view B.



THE GIANT UFO

Specifications



Length : 14.3m
Width : 8.5m
Height : 5.4m

Colour scheme ● ●

Components List

Custom tunnel slide
Tube slide with transparent acrylic cover
Metal cage structure

Ages:
5 - 12
years

ASTM
Certified

Top View - Safe Use Zone

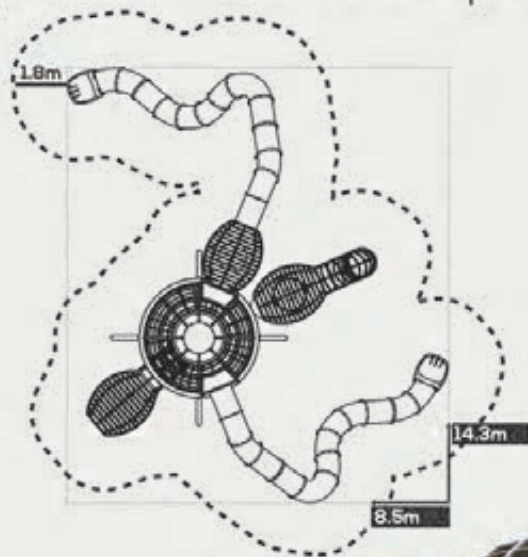

Perspective View



Theoretically, there's a maximum height that our tunnel slides can be assembled together, but that is way higher than how much friction the human body can withstand before our bottoms get quite hot and the dizziness sets in. With that in mind, we still did go pretty high for sure.

Location : Putrajaya, Malaysia



CHALLENGE COURSE

Specifications



Length : 17.0m
Width : 10.3m
Height : 3.1m

Colour scheme ● ●

Components List

- Square deck
- Triangle deck
- Suspended net bridge
- Straight track ride
- Wavy net climber
- Suspension rope bridge
- S-track ride
- Wobble stepper
- Curved balancing beam
- Net cross
- HDPE checkpoint signage
- Handhold
- Ring

Ages:
5 - 12
years

30 - 35
Children

Top View - Safe Use Zone

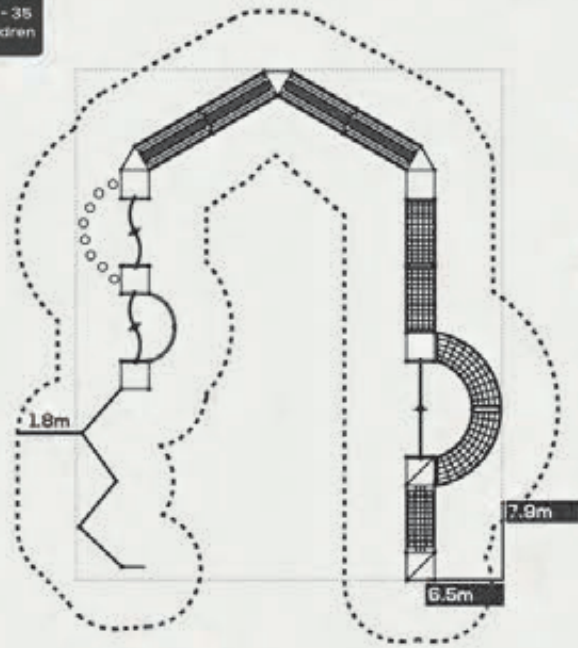

Perspective View

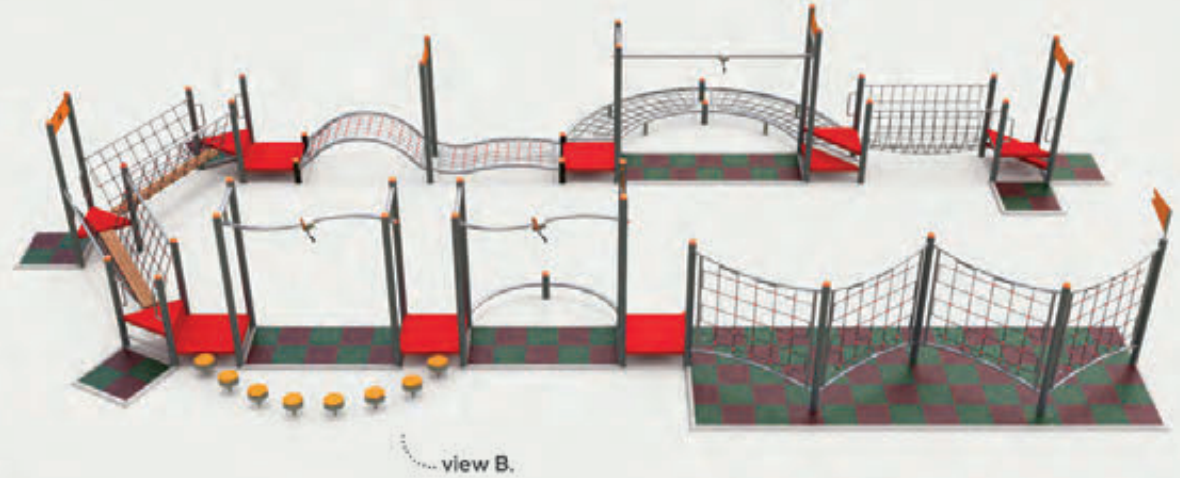

*Rubber tiles added for visual purpose only. Flooring sold separately.



Location : Shah Alam, Malaysia

Extensive use of ropes has somewhat become our fetish currently. Not what you might think of course, but the wibbly-wobbly nature of stretched ropes over a length presents its own unique challenge. Progress through a full course towards the finish line and see whether you're already at the end of your rope.

If a kid would spend 2 hours playing on a dry playground, it would take double that to finish off on a wet one. Water can do just amazing stuff. But whatever goes behind wetting a playground is a different game altogether. Turning the tap on to bring all the fun is the job only specialists can deliver.

WATERPLAY SERIES

Integrated Playset

Sicomel
children play equipment system





Perspective View

Top View - Safe Use Zone

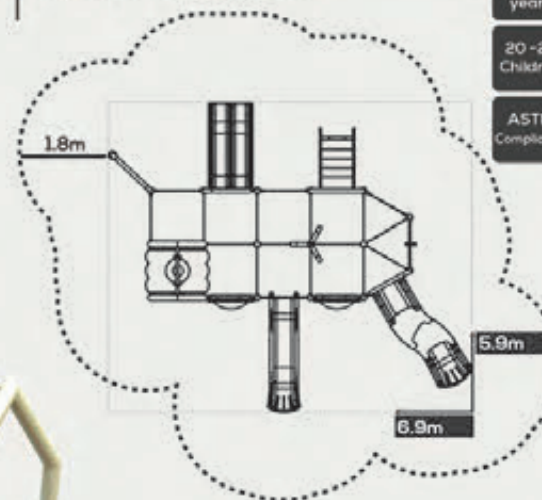

view B.



view A.

Ages:
5 - 12
years

20 - 25
Children

ASTM
Compliance

SCC16171-297A2

Specifications



Length : 6.9m
Width : 5.9m
Height : 4.4m

Colour scheme ● ● ●

Components List

- Square deck
- Triangle deck
- S-Anacanda slide
- Double slide
- Astro slide
- Entrance ladder
- Bucket water tropper
- Triple sprinkler
- Arch sprinkler
- Water shower
- L-sprinkler
- Wave panel
- Castle panel
- Bubble panel
- Steering panel
- Busy panel
- Ship anchor panel
- Safety panel w/ water gun
- Whale deco
- Kickplate
- Flush post cap
- Posts w/ cap



SCC16171-053A2B

Specifications



Length : 8.9m
Width : 4.6m
Height : 6.3m

Colour scheme ● ● ●

Components List

- Square deck
- Triangle deck
- Spiral tunnel slide
- Double slide
- Rock climber
- Bubble panel
- Bucket water trapper w/ awning
- Pirate telescope panel
- Steering panel
- Ship bow panel
- Buoy panel
- Bee face panel
- Castle panel
- Ship anchor panel
- Kickplate
- Ship sails
- Flag deco
- Handhold

Ages:
5 - 12
years

20 - 30
Children

ASTM
Compliance

Top View - Safe Use Zone

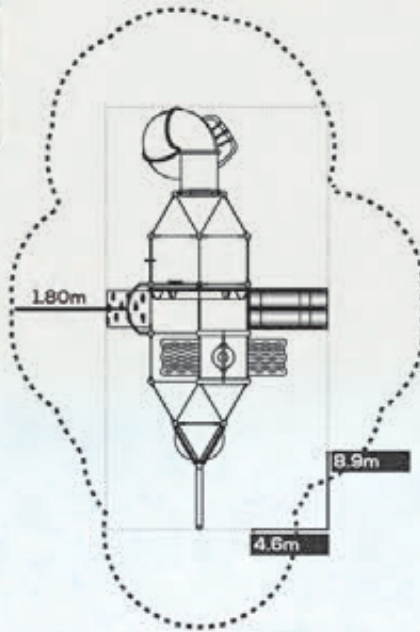

Perspective View

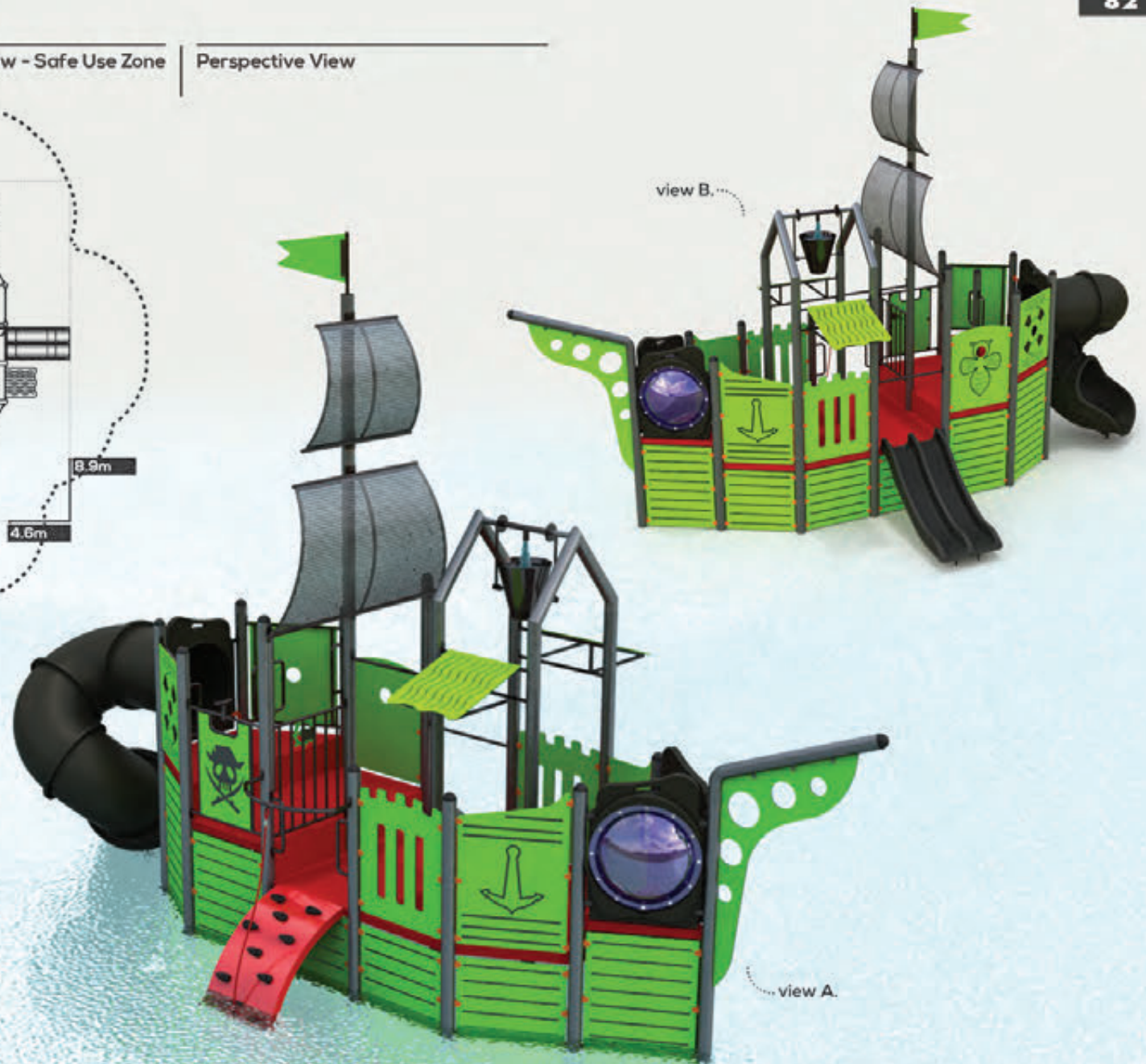

All waterplay equipment can be purchased as a package or individually. Regardless of the preference, all the plumbing works will be done up to the same high standard to ensure everything flows nicely.

Location : Ara Damansara, Malaysia



SCC18302-124

Specifications



Length : 10.4m
Width : 8.8m
Height : 4.9m

Colour scheme ● ● ● ● ●

Components List

- Square deck
- Triangle deck
- Balcony deck
- Spiral tunnel slide
- Balcony panel
- S-tunnel slide
- Astro slide
- Kickplate
- Posts w/ cap
- The Ship HDPE side panel
- Upper deck HDPE side panel
- Half HDPE side panel
- Vertical ladder
- XOX panel
- HDPE steering panel
- Telescope panel
- Rope sails tether
- Small sail
- Triangle flag
- Bubble panel
- Kickplate
- Rung
- Handhold
- Ship bow deco
- Ship stern deco
- Bucket water trapper
- Ramp
- Safety panel

Ages:
5 - 12
years

20 - 30
Children

Top View - Safe Use Zone

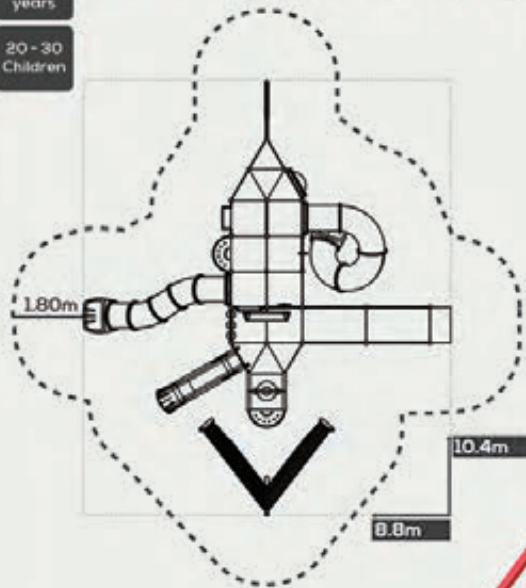

Perspective View

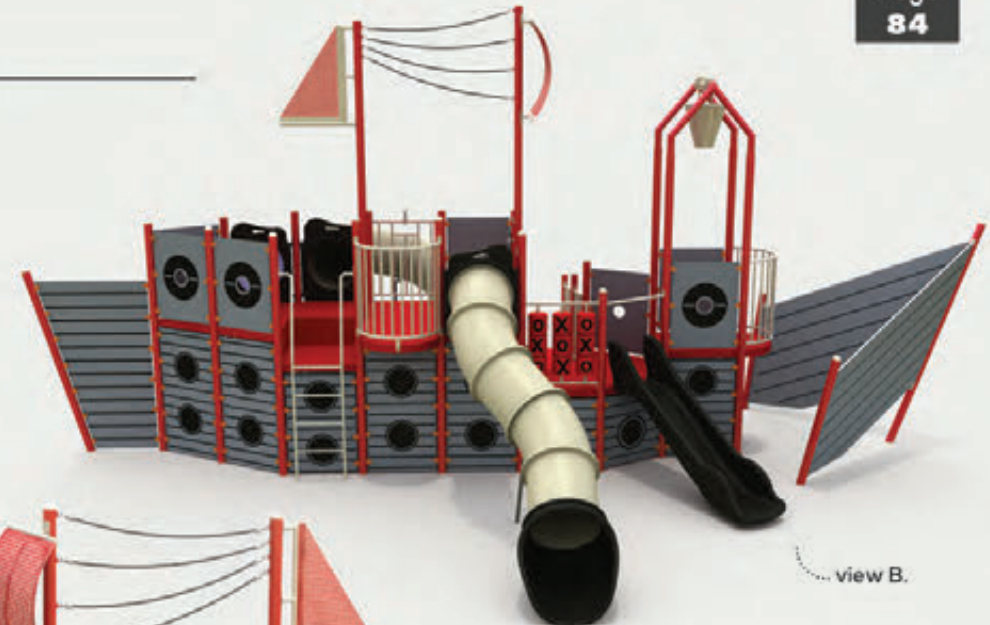

view B.

view A.



A ship might be at home in the water. But we can push the boat out and apply water functionalities to ANY of our integrated sets. The possibilities are endless. Just don't let your imagination run dry.

Location : Sungkai, Malaysia





L : 1.5M
 W : 0.6M
 H : 2.9M

WATERLILY SPLASH



Ø : 2.0M
 H : 2.8M

MUSHROOM WATERFALL



Ø : 0.9M Ø : 0.3M

FOUNTAIN NOZZLE

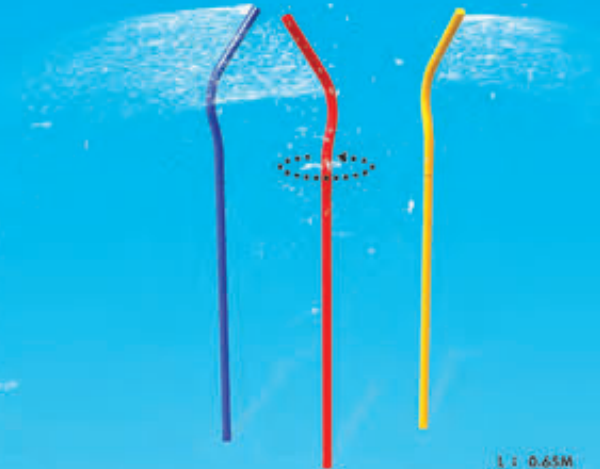

L : 0.65M
 W : 0.3M
 H : 3.0M

MECHANICAL ROTATING SPOUT



L : 2.1M
 W : 1.4M
 H : 3.8M

BUCKET WATER TRAPPER



L : 2.1M
 W : 2.1M
 H : 3.5M

COCONUT TREE SHOWER



L : 0.8M
 W : 2.5M
 H : 2.1M

RAIN MAKER



L : 2.1M
 W : 2.1M
 H : 2.8M

FLOWER DRIP



L : 2.4M
W : 0.2M
H : 2.5M

GIRAFFE WATERSPRAY



L : 0.5M
W : 0.2M
H : 1.0M

WATER SHOOTER



L : 2.5M
W : 0.3M
H : 1.6M

ARCH TUNNEL

WATERPLAY
INDEPENDENT
ITEMS

A series of shooters, sprinklers, splashers, and many others are professionally fabricated and plumbed to complement the main water playground set, or as standalone water features. These can be partially submerged in a pool of water or mounted right above the water level.

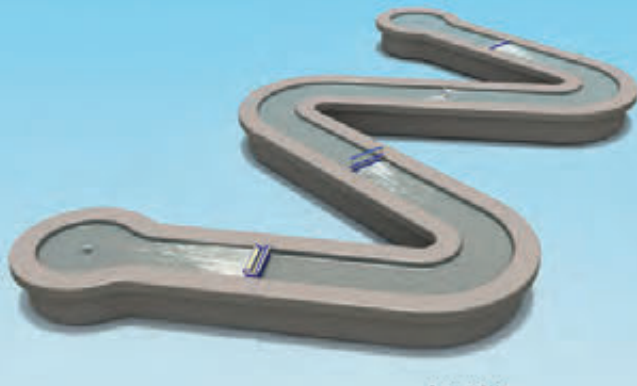

L : 8.0M
W : 3.9M
H : 0.4M

WATER STREAM



L : 4.9M
W : 0.9M
H : 2.5M

ORCA SPRINKLER



L : 1.6M
W : 1.2M
H : 2.5M

ELLYHEAD WATERSPRAY



What's better than a playground set? A stunning playground set at the center with several independent items as its peripherals. That would certainly be more enticing and adding more values in the play sense.

INDEPENDENT ITEMS



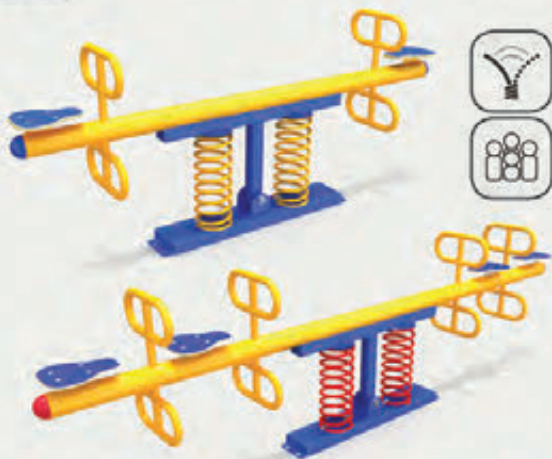

FUN SEE-SAW

2 to 4 seaters
Age limit : 2 - 12 years
Colour scheme ● ●

L : 2.0M	L : 3.0M
W : 0.3M	W : 0.3M
H : 0.8M (2 seater)	H : 0.8M (4 seater)

FUN SEE-SAW ADD-ONS



PELANGI SEE-SAW

2 seaters
Age limit : 2 - 12 years
Colour scheme ● ●

L : 2.8M
W : 0.3M
H : 1.1M

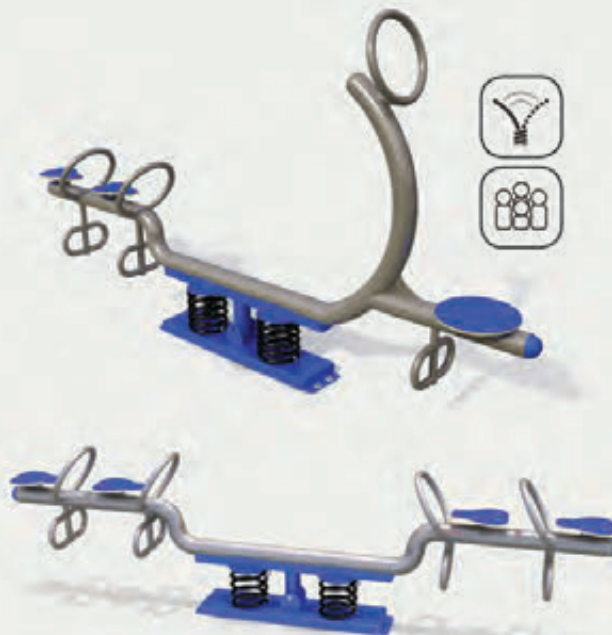

GENKO SEE-SAW

3 and 4 seaters
Age limit : 2 - 12 years
Colour scheme ● ●

L : 2.9M	L : 3.0M
W : 0.35M	W : 0.35M
H : 1.5M (3 seater)	H : 0.84M (4 seater)

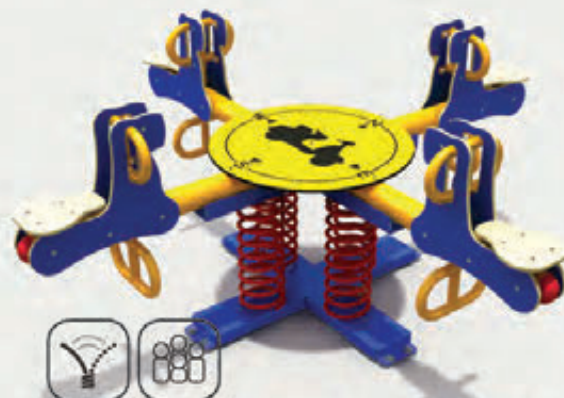

SCOOTER 4 SEATER SEE-SAW

4 seaters
Age limit : 2 - 12 years
Colour scheme ● ●

L : 2.0M
W : 2.0M
H : 0.9M



DEZY SEE-SAW

2 seaters
Age limit : 2 - 5 years
Colour scheme ● ●

L : 1.0M
W : 0.35M
H : 0.77M



STARDUST SEE-SAW

4 seaters
Age limit : 2 - 12 years
Colour scheme ● ●

L : 1.1M
W : 1.1M
H : 0.8M



ORCHID SEE-SAW

4 seaters
Age limit : 2 - 12 years
Colour scheme ● ●

L : 1.6M
W : 1.6M
H : 0.8M



FUN SWING

2 to 6 seater favourite
Age Allocation : 5 - 12
Colour scheme ● ●

L : 3.9M
W : 1.5M
H : 2.8M
(2 seater)



MODE SWING

2 to 6 Seaters modern style swing
Age Allocation : 5 - 12
Colour scheme ●

L : 3.5M
W : 1.3M
H : 2.1M
(2 seater)

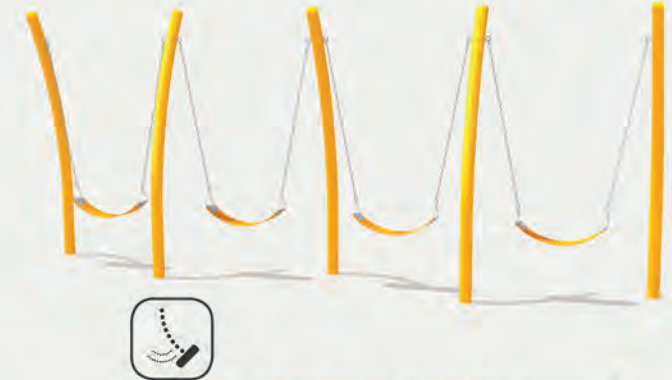

CURVED-ACROSS SEATS

Expandable to accommodate many seats
Age Allocation : Strictly for 2 - 5 years old only
Colour scheme ● ●

L : 0.7M
W : 1.3M
H : 2.1M
(single seater)



FOREST VINES

Expandable to accommodate more seaters
Age Allocation : 5 - 12
Colour scheme ● ●

L : 6.6M
W : 5.8M
H : 2.6M



HEX SWING

6 seater communal swing
Age Allocation : 5 - 12
Colour scheme ●

L : 6.6M
W : 5.8M
H : 2.6M



SINGLE HAMMOCK SEAT

Single seater mini swing
Age Allocation : 2 - 5
Colour scheme ● ●

L : 0.9M
W : 1.0M
H : 1.4M

ACCESSORIES

Swing seats with chains



Flat seat



Toddler seat

Location : Shah Alam, Malaysia





360 TREADMILL

4 players
Age limit : 5 - 12 years
Colour scheme ● ●

Ø : 1.8M
H : 0.4M



MERRY GO ROUND

2 - 6 players
Age limit : 5 - 12 years
Colour scheme ● ●

Ø : 1.8M
H : 1.1M



BUCKET SPINNERS

1 player each unit
Age limit : 2 - 12 years
Colour scheme ● ● ●

L : 0.76M
W : 0.74M
H : 0.7M

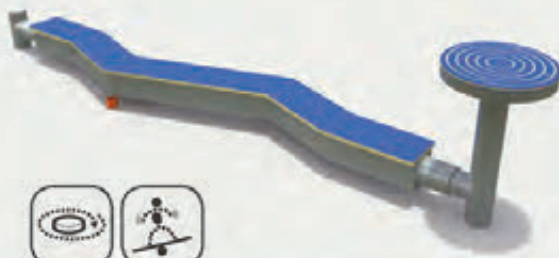

ZIG-ZAG BALANCING BEAM

1 - 2 players
Age limit : 5 - 12 years
Colour scheme ● ●

L : 2.3M
W : 0.4M
H : 0.5M



LOTUS CAROUSEL

4 players
Age limit : 5 - 12 years
Colour scheme ● ●

L : 1.3M
W : 1.3M
H : 0.9M



MOONWALK SPINNER

1 - 2 players
5 - 12 years
Colour scheme ● ●

Ø : 0.4M
H : 1.1M



MINI APOLLO

5 - 10 players
Age limit : 5 - 12 years
Colour scheme ● ●

Ø : 2.0M
H : 2.4M

**TINY
TOWNSHIP
COLLECTION**

2 to 5 years old
(each sold separately)

Set up your own
fictional small town
with these items.
May we suggest
a customized
patterned safety
flooring to complete
the theme?



GAS STATION

2 - 4 players

Colour scheme ● ● ●

L : 1.2M
W : 1.0M
H : 1.9M



SMART CAR

2 - 4 players

Colour scheme ● ● ●

L : 1.2M
W : 0.9M
H : 1.0M



CLASSIC POLICE TRUCK

4 - 6 players

Colour scheme ● ● ●

L : 1.8M
W : 1.2M
H : 1.6M



TOLL BOOTH

2 players

Colour scheme ● ● ●

L : 0.9M
W : 0.75M
H : 1.8M



PLAY HOUSE

2 - 4 players

Colour scheme ● ● ● ●

L : 2.4M
W : 0.4M
H : 0.5M



FIRE HOUSE

4 - 6 players

Colour scheme ● ● ● ●

L : 2.4M
W : 0.4M
H : 0.5M



FIRE ENGINE

4 - 6 players

Colour scheme ● ● ●

L : 2.1M
W : 1.2M
H : 2.0M

Safety Area

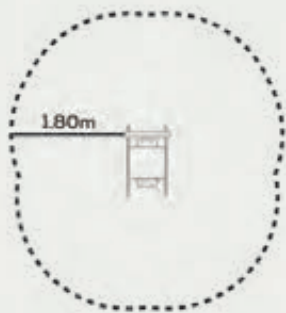

L 10.6-1.1M
W: 0.3M
H 10.5-0.7M



Bee



Bird of Paradise



komodo



Alphabet X



Alphabet G



Whale



Bulldozer



Fat Crab



Alphabet O

DUAL TYPE

More interesting designs are produced monthly. Contact us to find out what's latest.

SINGLE TYPE

Safety Area

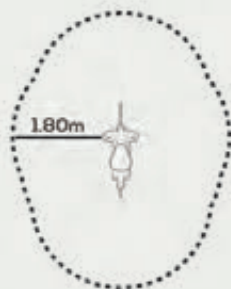

L 10.6-1.1M
W: 0.3M
H 10.6-0.9M



Vespa



Giraffe



Elly



Rooster



Truck



Tiger



Horse



Crush



Location : Cameron Highlands, Malaysia



HOME GARDEN

4 - 6 players
Age limit : 2 - 5 years
Colour scheme ● ● ● ● ●

L : 1.7M
W : 1.4M
H : 1.2M



MUSICAL SPACE

5 - 10 players
Age limit : 2 - 12 years
Colour scheme ● ● ● ● ●

L : 3.0M
W : 1.8M
H : 2.1M



SAILBOAT

1 - 2 players
Age limit : 2 - 5 years
Colour scheme ● ● ● ● ●

L : 1.6M
W : 1.0M
H : 2.2M

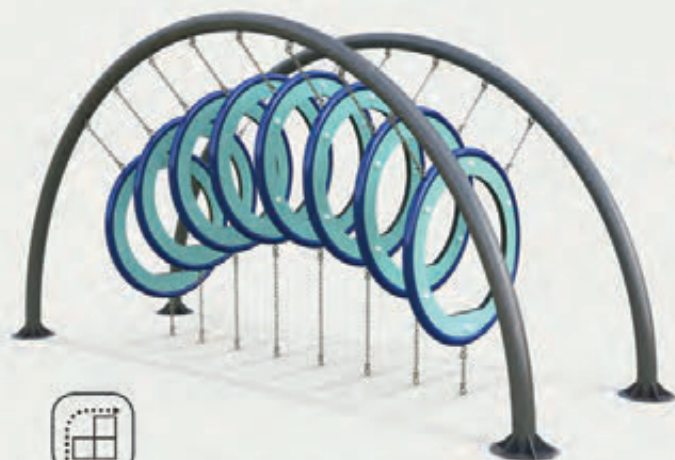

RPS ZERO THREE

2 - 5 players
Age limit : 5 - 12 years
Colour scheme ● ● ● ● ●

L : 4.3M
W : 1.5M
H : 2.0M



ACOUSTIC MOUND

8 - 10 players
Age limit : 5 - 12 years
Colour scheme ● ● ● ● ●

mound Ø: 2.8M
L : 4.2M
W : 4.1M
H : 2.0M



LA PLAQUE

4 - 6 players
Age limit : 5 - 12 years
Colour scheme ● ● ● ● ●

L : 5.4M
W : 1.9M
H : 2.1M

OUTDOOR FITNESS

PROBUILDER
OUTDOOR FITNESS SYSTEM

A man in a blue t-shirt and light-colored shorts is using a black outdoor fitness machine with red accents. He is leaning forward, gripping the handles. In the background, several other people are standing near other fitness equipment. The setting is an outdoor park area with a building in the background.

The Pro-Builder Outdoor Fitness series sports a sleek new patented design unlike any other in the market. Common parts shared across the range makes maintenance absolutely a no sweat affair. With good looks and proven functionalities, it's such a great value for a nice workout under the blue sky.

ROWING MACHINE

L : 1.7M
W : 0.8M
H : 1.2M



Muscle Group



WAIST AND BACK MASSAGER

L : 1.1M
W : 0.49M
H : 1.7M



Muscle Group



HAND BIKE

L : 1.5M
W : 0.46M
H : 1.4M



Muscle Group



The OUTDOOR GYM SERIES

MINI SKI

L : 1.2M
W : 0.79M
H : 1.0M



Muscle Group



LEG STRETCH

L : 1.3M
W : 1.2M
H : 1.3M



Muscle Group



LAT PULLDOWN

L : 1.5M
W : 1.0M
H : 1.9M



Muscle Group





{ Parks and open spaces need equipment like the **OUTDOOR GYM SERIES** that are ergonomically designed to correspond with the body's natural movement, preventing musculoskeletal pain or injury. All the moving mechanisms have undergone various testing and improvements using high grade bearings for a polished smooth operation. }



<p>PARALLEL BARS</p> <p>L : 2.4M W : 1.2M H : 1.0M</p>  <p>Muscle Group</p> 	<p>VERTICAL CLIMBER</p> <p>L : 0.84M W : 0.46M H : 2.2M</p>  <p>Muscle Group</p> 	<p>CHIN UP</p> <p>L : 2.2M W : 0.63M H : 2.2M</p>  <p>Muscle Group</p> 	<p>SPRING UP</p> <p>L : 2.2M W : 0.53M H : 1.2M</p>  <p>Muscle Group</p> 
---	--	--	--

{ **The PARCOURSE SERIES** }

<p>STRAIGHT SIT-UP</p> <p>L : 1.9M W : 0.4M H : 1.0M</p>  <p>Muscle Group</p> 	<p>KNEE LIFT</p> <p>L : 0.66M W : 0.5M H : 1.9M</p>  <p>Muscle Group</p> 	<p>JUMP TOUCH</p> <p>L : 0.66M W : 0.59M H : 2.2M</p>  <p>Muscle Group</p> 	<p>HAMSTRING STRETCH</p> <p>L : 1.9M W : 0.37M H : 1.4M</p>  <p>Muscle Group</p> 
---	--	---	---

BACK STRETCH

L : 0.55M
W : 0.75M
H : 1.9M



Muscle Group

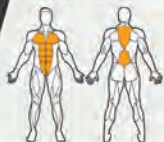

ACHILLES STRETCH

L : 0.8M
W : 0.46M
H : 2.2M



Muscle Group



STEP UP

L : 0.8M
W : 0.77M
H : 1.2M



Muscle Group



PUMP UP

L : 1.0M
W : 0.37M
H : 1.4M



Muscle Group



Feeling tight and stiff at the joints? The couch potatoes of today's society are not fully utilizing the body's whole range of motion. The PARCOURSE SERIES are made to turn back those potatoes into lean meat. A wide range of stretches and work outs will bring back strength, agility, and balance in an individual.

LOG HOP

L : 2.1M
W : 2.1M
H : 1.4M



Muscle Group



BODY LIFT

L : 0.89M
W : 0.77M
H : 2.2M



Muscle Group



BALANCING BEAM

L : 2.8M
W : 2.4M
H : 1.2M



Muscle Group



CROSS CHALLENGER

L : 3.3M
W : 0.95M
H : 2.0M



Muscle Group





BUGS BENCH (CATERPILLAR)

Seating capacity : 2 adults L : 0.6M
W : 1.6M
Colour scheme ● ● H : 1.0M



BUGS BENCH (LADYBIRD)

Seating capacity : 2 adults L : 0.6M
W : 1.5M
Colour scheme ● ● H : 1.0M



LADYBIRD PICNIC TABLE

Seating capacity : 4 adults L : 1.9M
W : 1.9M
Colour scheme ● ● ● ● H : 0.7M



CHESSBOARD PICNIC TABLE

Seating capacity : 4 adults L : 1.9M
W : 1.9M
Colour scheme ● ● ● ● H : 0.7M



MODERN BIN

L : 0.48M
W : 0.6M
H : 0.95M



BUGS BENCH (DRAGONFLY)

Seating capacity : 3 adults L : 0.5M
W : 2.1M
Colour scheme ● ● ● H : 1.0M



BUGS BENCH (BUTTERFLY)

Seating capacity : 2 adults L : 0.5M
W : 1.5M
Colour scheme ● ● ● H : 1.0M



WPC PICNIC TABLE

Seating capacity : 4 adults L : 1.4M
W : 1.5M
Colour scheme ● ● H : 0.8M



METAL PARK BENCH

Seating capacity : 2 adults L : 0.55M
W : 1.2M
Colour scheme ● ● H : 1.0M



FLORAL MODERN BIN

L : 0.48M
W : 0.6M
H : 0.95M



SNAKE TODDLER BENCH

Seating capacity : 8 toddlers L : 2.0M
W : 0.3M
Colour scheme ● ● H : 0.14M



SIMPLE PUR BENCH

Seating capacity : 3 adults L : 1.5M
W : 0.4M
Colour scheme ● ● ● H : 0.36M



BUFFALO ARCH BENCH

Seating capacity : 2 adults L : 0.6M
W : 1.3M
Colour scheme ● ● ● H : 0.8M



TRELLIS BENCH

Seating capacity : 3 adults L : 1.3M
W : 1.9M
Colour scheme ● ● ● H : 0.45M



RECEPTACLE BIN

Ø : 0.6M
H : 1.1M



PUTRA BIN

Ø : 0.8M
H : 1.2M

Kids jump and fall, roll and tumble, knock and bounce, all are part and parcel of playing. It's incumbent upon us, as a playground manufacturer to provide the safest possible play environment. According to safety standard, soft impact absorbing flooring is mandatory for any playground area.

PRO-SAFE BENEFITS

- Excellent dimensional stability under varying temperatures
- Soft and comfortable underfoot feel and safe to walk on barefooted
- Impact absorbent and reduces the risk of injury from falling
- Ideal for creating designs of different shapes and colours
- Withstand scuffing, grinding, and heavy foot traffic
- Broad colour selection and custom colour option
- Requires no sanding, repainting, or special surface treatment
- Made from recycled material and non-toxic substances



PRODUCTS

EPDM Seamless Flooring

Stands for Ethylene Propylene Diene Monomer Rubber. It's actually a colourized mixture of natural and synthetic rubber shredded into small granules. These granules are skillfully laid on the surface to create various forms of designs for your flooring. A type of organic non-toxic base moulded binder is used to keep your flooring together for a long time.

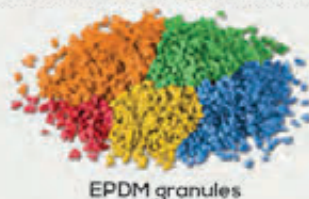
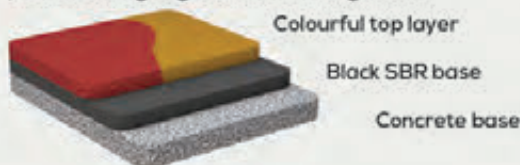

Rubber Tiles

PRO-SAFE absorbing rubber tiles are premade with strict tolerances to ensure uniform dimension and colour, resulting in perfectly tileable 0.5m x 0.5m pieces. Choose from available thickness of 20mm, 50mm, or 70mm to cater for the different levels of impact absorbing capacity required. Using rubber tiles is a quick safety flooring solution without compromising quality and visual appeal.



EPDM COLOUR SELECTIONS

Not all colours are available at all times for all seasons. Do contact our representatives to enquire.



Malaysia's Premier Play Equipment Manufacturer

Pro-Landscape Structure Sdn. Bhd.
No. 53 & 54, Jalan BRP 8/2,
Bukit Rahman Putra Industrial Park,
47000 Sg. Buloh, Selangor, Malaysia

email: info@prolandscape.com.my
website: www.prolandscape.com.my

T: +603.6140.3018 F: +603.6140.3027

Agent / Distributor

